

NOTION[®]
"Enlighten the World"

NOTION[®]
"Enlighten the World"

📍 C-112, Maruti Industrial Estate, Part-C, Opp. Fire Station, Naroda Road,
Memco, Ahmedabad 380025, Gujarat, India
✉ sales@notionelectronics.com 🌐 www.notionelectronics.com
☎ +91 97248 79970 / 99980 75864 / 70418 73644

Illuminating Life
Intelligently

Blaze into glory with the new
NOTION LED LIGHTINGS
Modern Design, Sturdy Body



NOTION[®]
"Enlighten the World"

**We Design Thoughtful,
 Luminaires and Poles.**

With a growing global footprint, Notion has successfully grown into one of India's leading manufacturers of architectural lighting poles & luminaires, be it contemporary or decorative. And we have done this by capitalizing on our industry knowledge and combining it with advanced optical engineering. Building the foundation of a solid interplay between architecture and luminaire, all our innovations and designs are shaped to enrich people's lives.

TABLE OF CONTENTS

| | |
|------------------------------------|-------|
| LED BOLLARD LIGHTS | 01-12 |
| LED DECORATIVE POLE | 13-28 |
| LED POST TOP LIGHTS | 29-34 |
| LED GATE LIGHTS | 35-41 |
| LED SPIKE LIGHTS | 42-43 |
| LED WALL LIGHTS | 44-48 |
| LED POOL & INGROUND BURIALS LIGHTS | 49-50 |
| LED FACADE LIGHTS | 51-52 |
| LED HANGING LIGHTS | 51-52 |
| LED LINEAR & MAGNETIC LIGHTS | 51-52 |
| LED PANEL LIGHTS | 53-54 |
| LED SPOT LIGHTS | 53-54 |
| LED COMMERCIAL LIGHTS | 53-54 |
| LED STREET LIGHT | 55-56 |
| LED FLOOD LIGHTS | 55-56 |
| LED HIGHBAY LIGHTS | 55-56 |



Fully
 Customized
 Designs



Metals
 and
 Finishes



Production
 and
 Assembly



Our Core
 Values



In-House
 Design



Quality
 Control



Optics



LED BOLLARD LIGHTS



PRODUCT CODE 1601 NEO
POWER 5W, 7W, 9W
CCT 3000K, 4000K, 6000K
MATERIAL TYPE M.S/ S.S / ALUMINIUM POWDER COATED
HEIGHT

| | | |
|--------|--------|--------|
| 300 MM | 600 MM | 900 MM |
|--------|--------|--------|

MRP

| | | |
|--|--|--|
| | | |
|--|--|--|



PRODUCT CODE 1602 ULTIMA
POWER 5W, 7W, 9W
CCT 3000K, 4000K, 6000K
MATERIAL TYPE M.S/ S.S / ALUMINIUM POWDER COATED
HEIGHT

| | | |
|--------|--------|--------|
| 300 MM | 600 MM | 900 MM |
|--------|--------|--------|

MRP

| | | |
|--|--|--|
| | | |
|--|--|--|



PRODUCT CODE 1603 KONAS
POWER 5W, 7W, 9W
CCT 3000K, 4000K, 6000K
MATERIAL TYPE M.S/ S.S / ALUMINIUM POWDER COATED
HEIGHT

| | | |
|--------|--------|--------|
| 300 MM | 600 MM | 900 MM |
|--------|--------|--------|

MRP

| | | |
|--|--|--|
| | | |
|--|--|--|



PRODUCT CODE 1604 CUBIC
POWER 5W, 7W, 9W
CCT 3000K, 4000K, 6000K
MATERIAL TYPE M.S/ S.S / ALUMINIUM POWDER COATED
HEIGHT

| | | |
|--------|--------|--------|
| 300 MM | 600 MM | 900 MM |
|--------|--------|--------|

MRP

| | | |
|--|--|--|
| | | |
|--|--|--|

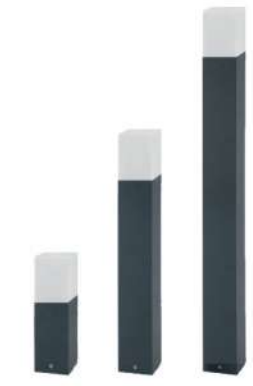

PRODUCT CODE 1605 COMPASS
POWER 5W, 7W, 9W
CCT 3000K, 4000K, 6000K
MATERIAL TYPE M.S/ S.S / ALUMINIUM POWDER COATED
HEIGHT

| | | |
|--------|--------|--------|
| 300 MM | 600 MM | 900 MM |
|--------|--------|--------|

MRP

| | | |
|--|--|--|
| | | |
|--|--|--|



PRODUCT CODE 1606 TRIDY
POWER 5W, 7W, 9W
CCT 3000K, 4000K, 6000K
MATERIAL TYPE M.S/ S.S / ALUMINIUM POWDER COATED
HEIGHT

| | | |
|--------|--------|--------|
| 300 MM | 600 MM | 900 MM |
|--------|--------|--------|

MRP

| | | |
|--|--|--|
| | | |
|--|--|--|



PRODUCT CODE 1607 WALKY
POWER 5W, 7W, 9W
CCT 3000K, 4000K, 6000K
MATERIAL TYPE M.S/ S.S / ALUMINIUM POWDER COATED
HEIGHT

| | | |
|--------|--------|--------|
| 300 MM | 600 MM | 900 MM |
|--------|--------|--------|

MRP

| | | |
|--|--|--|
| | | |
|--|--|--|



PRODUCT CODE 1608 OPPO
POWER 5W, 7W, 9W
CCT 3000K, 4000K, 6000K
MATERIAL TYPE M.S/ S.S / ALUMINIUM POWDER COATED
HEIGHT

| | | |
|--------|--------|--------|
| 300 MM | 600 MM | 900 MM |
|--------|--------|--------|

MRP

| | | |
|--|--|--|
| | | |
|--|--|--|



PRODUCT CODE 1609 AVTAR
POWER 5W, 7W, 9W
CCT 3000K, 4000K, 6000K
MATERIAL TYPE M.S/ S.S / ALUMINIUM POWDER COATED
HEIGHT

| | | |
|--------|--------|--------|
| 300 MM | 600 MM | 900 MM |
|--------|--------|--------|

MRP

| | | |
|--|--|--|
| | | |
|--|--|--|



PRODUCT CODE 1610 OPEL
POWER 5W, 7W, 9W
CCT 3000K, 4000K, 6000K
MATERIAL TYPE M.S/ S.S / ALUMINIUM POWDER COATED
HEIGHT 300 MM 600 MM 900 MM
MRP



PRODUCT CODE 1611 MARVELL
POWER 5W, 7W, 9W
CCT 3000K, 4000K, 6000K
MATERIAL TYPE M.S/ S.S / ALUMINIUM POWDER COATED
HEIGHT 300 MM 600 MM 900 MM
MRP



PRODUCT CODE 1612 VIYOO
POWER 5W, 7W, 9W
CCT 3000K, 4000K, 6000K
MATERIAL TYPE M.S/ S.S / ALUMINIUM POWDER COATED
HEIGHT 300 MM 600 MM 900 MM
MRP



PRODUCT CODE 1619 EMBLEM
POWER 10W, 15W,
CCT 3000K, 4000K, 6000K
MATERIAL TYPE M.S/ S.S / ALUMINIUM POWDER COATED
HEIGHT 600 MM, 900MM, 1200 MM
MRP



PRODUCT CODE 1620 EMBLAZE
POWER 10W, 15W,
CCT 3000K, 4000K, 6000K
MATERIAL TYPE M.S/ S.S / ALUMINIUM POWDER COATED
HEIGHT 600 MM, 900MM, 1200 MM
MRP



PRODUCT CODE 1621 BOLTZ
POWER 10W, 15W,
CCT 3000K, 4000K, 6000K
MATERIAL TYPE M.S/ S.S / ALUMINIUM POWDER COATED
HEIGHT 600 MM, 900MM, 1200 MM
MRP



PRODUCT CODE 1613 PRISMA
POWER 5W, 7W, 9W
CCT 3000K, 4000K, 6000K
MATERIAL TYPE M.S/ S.S / ALUMINIUM POWDER COATED
HEIGHT 300 MM 600 MM 900 MM
MRP



PRODUCT CODE 1614 CARVA
POWER 5W, 7W, 9W
CCT 3000K, 4000K, 6000K
MATERIAL TYPE M.S/ S.S / ALUMINIUM POWDER COATED
HEIGHT 300 MM 600 MM 900 MM
MRP



PRODUCT CODE 1615 BASKIT
POWER 5W, 7W, 9W
CCT 3000K, 4000K, 6000K
MATERIAL TYPE M.S/ S.S / ALUMINIUM POWDER COATED
HEIGHT 300 MM 600 MM 900 MM
MRP



PRODUCT CODE 1622 PHOTON
POWER 10W, 15W,
CCT 3000K, 4000K, 6000K
MATERIAL TYPE M.S/ S.S / ALUMINIUM POWDER COATED
HEIGHT 600 MM, 900MM, 1200 MM
MRP

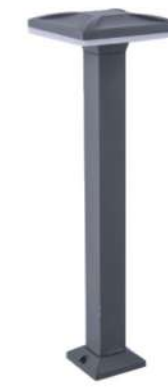

PRODUCT CODE 1623 SQUARON
POWER 10W, 15W,
CCT 3000K, 4000K, 6000K
MATERIAL TYPE M.S/ S.S / ALUMINIUM POWDER COATED
HEIGHT 600 MM, 900MM, 1200 MM
MRP



PRODUCT CODE 1624 REDON
POWER 10W, 15W,
CCT 3000K, 4000K, 6000K
MATERIAL TYPE M.S/ S.S / ALUMINIUM POWDER COATED
HEIGHT 600 MM, 900MM, 1200 MM
MRP



PRODUCT CODE 1616 ESPHERA
POWER 5W, 7W, 9W
CCT 3000K, 4000K, 6000K
MATERIAL TYPE M.S/ S.S / ALUMINIUM POWDER COATED
HEIGHT 300 MM 600 MM 900 MM
MRP



PRODUCT CODE 1617 OVUL
POWER 5W, 7W, 9W
CCT 3000K, 4000K, 6000K
MATERIAL TYPE M.S/ S.S / ALUMINIUM POWDER COATED
HEIGHT 300 MM 600 MM 900 MM
MRP



PRODUCT CODE 1618 KALASH
POWER 5W, 7W, 9W
CCT 3000K, 4000K, 6000K
MATERIAL TYPE M.S/ S.S / ALUMINIUM POWDER COATED
HEIGHT 300 MM 600 MM 900 MM
MRP



PRODUCT CODE 1625 ZEST
POWER 10W, 15W,
CCT 3000K, 4000K, 6000K
MATERIAL TYPE M.S/ S.S / ALUMINIUM POWDER COATED
HEIGHT 600 MM, 900MM, 1200 MM
MRP



PRODUCT CODE 1626 BROLLY
POWER 10W, 15W,
CCT 3000K, 4000K, 6000K
MATERIAL TYPE M.S/ S.S / ALUMINIUM POWDER COATED
HEIGHT 600 MM, 900MM, 1200 MM
MRP



PRODUCT CODE 1627 FLOURISH
POWER 10W, 15W,
CCT 3000K, 4000K, 6000K
MATERIAL TYPE M.S/ S.S / ALUMINIUM POWDER COATED
HEIGHT 600 MM, 900MM, 1200 MM
MRP

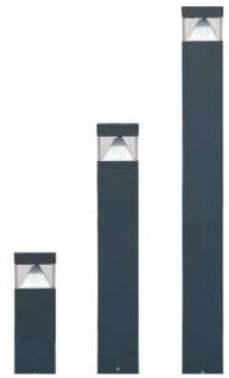

PRODUCT CODE 1628 FILLET
POWER 10W, 15W,
CCT 3000K, 4000K, 6000K
MATERIAL TYPE M.S/ S.S / ALUMINIUM POWDER COATED
HEIGHT 600 MM, 900MM, 1200 MM
MRP



PRODUCT CODE 1629 SLIMAX
POWER 10W, 15W,
CCT 3000K, 4000K, 6000K
MATERIAL TYPE M.S/ S.S / ALUMINIUM POWDER COATED
HEIGHT 600 MM, 900MM, 1200 MM
MRP



PRODUCT CODE 1630 DUO
POWER 10W, 15W,
CCT 3000K, 4000K, 6000K
MATERIAL TYPE M.S/ S.S / ALUMINIUM POWDER COATED
HEIGHT 600 MM, 900MM, 1200 MM
MRP



PRODUCT CODE 1637 LEGO
POWER 10W, 15W,
CCT 3000K, 4000K, 6000K
MATERIAL TYPE M.S/ S.S / ALUMINIUM POWDER COATED
HEIGHT 600 MM, 900MM, 1200 MM
MRP



PRODUCT CODE 1638 TENGO
POWER 10W, 15W,
CCT 3000K, 4000K, 6000K
MATERIAL TYPE M.S/ S.S / ALUMINIUM POWDER COATED
HEIGHT 600 MM, 900MM, 1200 MM
MRP



PRODUCT CODE 1639 RINGO
POWER 10W, 15W,
CCT 3000K, 4000K, 6000K
MATERIAL TYPE M.S/ S.S / ALUMINIUM POWDER COATED
HEIGHT 600 MM, 900MM, 1200 MM
MRP



PRODUCT CODE 1631 FORMAX
POWER 10W, 15W,
CCT 3000K, 4000K, 6000K
MATERIAL TYPE M.S/ S.S / ALUMINIUM POWDER COATED
HEIGHT 600 MM, 900MM, 1200 MM
MRP



PRODUCT CODE 1632 ANTRIM
POWER 10W, 15W,
CCT 3000K, 4000K, 6000K
MATERIAL TYPE M.S/ S.S / ALUMINIUM POWDER COATED
HEIGHT 600 MM, 900MM, 1200 MM
MRP



PRODUCT CODE 1633 TRIGONO
POWER 10W, 15W,
CCT 3000K, 4000K, 6000K
MATERIAL TYPE M.S/ S.S / ALUMINIUM POWDER COATED
HEIGHT 600 MM, 900MM, 1200 MM
MRP



PRODUCT CODE 1640 DULUX
POWER 10W, 15W,
CCT 3000K, 4000K, 6000K
MATERIAL TYPE M.S/ S.S / ALUMINIUM POWDER COATED
HEIGHT 600 MM, 900MM, 1200 MM
MRP



PRODUCT CODE 1641 SOLUX
POWER 10W, 15W,
CCT 3000K, 4000K, 6000K
MATERIAL TYPE M.S/ S.S / ALUMINIUM POWDER COATED
HEIGHT 600 MM, 900MM, 1200 MM
MRP



PRODUCT CODE 1642 ROLUX
POWER 10W, 15W,
CCT 3000K, 4000K, 6000K
MATERIAL TYPE M.S/ S.S / ALUMINIUM POWDER COATED
HEIGHT 600 MM, 900MM, 1200 MM
MRP



PRODUCT CODE 1634 BOXY
POWER 10W, 15W,
CCT 3000K, 4000K, 6000K
MATERIAL TYPE M.S/ S.S / ALUMINIUM POWDER COATED
HEIGHT 600 MM, 900MM, 1200 MM
MRP



PRODUCT CODE 1635 FOXY
POWER 10W, 15W,
CCT 3000K, 4000K, 6000K
MATERIAL TYPE M.S/ S.S / ALUMINIUM POWDER COATED
HEIGHT 600 MM, 900MM, 1200 MM
MRP



PRODUCT CODE 1636 ROXY
POWER 10W, 15W,
CCT 3000K, 4000K, 6000K
MATERIAL TYPE M.S/ S.S / ALUMINIUM POWDER COATED
HEIGHT 600 MM, 900MM, 1200 MM
MRP



PRODUCT CODE 1643 ENZO
POWER 10W, 15W,
CCT 3000K, 4000K, 6000K
MATERIAL TYPE M.S/ S.S / ALUMINIUM POWDER COATED
HEIGHT 600 MM, 900MM, 1200 MM
MRP



PRODUCT CODE 1644 LORENZO
POWER 10W, 15W,
CCT 3000K, 4000K, 6000K
MATERIAL TYPE M.S/ S.S / ALUMINIUM POWDER COATED
HEIGHT 600 MM, 900MM, 1200 MM
MRP



PRODUCT CODE 1645 RENZO
POWER 10W, 15W,
CCT 3000K, 4000K, 6000K
MATERIAL TYPE M.S/ S.S / ALUMINIUM POWDER COATED
HEIGHT 600 MM, 900MM, 1200 MM
MRP



PRODUCT CODE 1646 OPTIMA
POWER 10W, 15W,
CCT 3000K, 4000K, 6000K
MATERIAL TYPE M.S/ S.S / ALUMINIUM POWDER COATED
HEIGHT 600 MM, 900MM, 1200 MM
MRP



PRODUCT CODE 1647 OPTIKA
POWER 10W, 15W,
CCT 3000K, 4000K, 6000K
MATERIAL TYPE M.S/ S.S / ALUMINIUM POWDER COATED
HEIGHT 600 MM, 900MM, 1200 MM
MRP



PRODUCT CODE 1648 OCULAR
POWER 10W, 15W,
CCT 3000K, 4000K, 6000K
MATERIAL TYPE M.S/ S.S / ALUMINIUM POWDER COATED
HEIGHT 600 MM, 900MM, 1200 MM
MRP



PRODUCT CODE 1655 ELANO
POWER 10W, 15W,
CCT 3000K, 4000K, 6000K
MATERIAL TYPE M.S/ S.S / ALUMINIUM POWDER COATED
HEIGHT 600 MM, 900MM, 1200 MM
MRP



PRODUCT CODE 1656 MILANO
POWER 10W, 15W,
CCT 3000K, 4000K, 6000K
MATERIAL TYPE M.S/ S.S / ALUMINIUM POWDER COATED
HEIGHT 600 MM, 900MM, 1200 MM
MRP



PRODUCT CODE 1656 VOLCANO
POWER 10W, 15W,
CCT 3000K, 4000K, 6000K
MATERIAL TYPE M.S/ S.S / ALUMINIUM POWDER COATED
HEIGHT 600 MM, 900MM, 1200 MM
MRP



PRODUCT CODE 1649 SYNERGIC
POWER 10W, 15W,
CCT 3000K, 4000K, 6000K
MATERIAL TYPE M.S/ S.S / ALUMINIUM POWDER COATED
HEIGHT 600 MM, 900MM, 1200 MM
MRP



PRODUCT CODE 1650 PLANO
POWER 10W, 15W,
CCT 3000K, 4000K, 6000K
MATERIAL TYPE M.S/ S.S / ALUMINIUM POWDER COATED
HEIGHT 600 MM, 900MM, 1200 MM
MRP



PRODUCT CODE 1651 RHOMBUS
POWER 10W, 15W,
CCT 3000K, 4000K, 6000K
MATERIAL TYPE M.S/ S.S / ALUMINIUM POWDER COATED
HEIGHT 600 MM, 900MM, 1200 MM
MRP



PRODUCT CODE 1658 DANGLE
POWER 10W, 15W,
CCT 3000K, 4000K, 6000K
MATERIAL TYPE M.S/ S.S / ALUMINIUM POWDER COATED
HEIGHT 600 MM, 900MM, 1200 MM
MRP



PRODUCT CODE 1659 MYSTIK
POWER 10W, 15W,
CCT 3000K, 4000K, 6000K
MATERIAL TYPE M.S/ S.S / ALUMINIUM POWDER COATED
HEIGHT 600 MM, 900MM, 1200 MM
MRP



PRODUCT CODE 1660 CRYSTAL CAGE
POWER 10W, 15W,
CCT 3000K, 4000K, 6000K
MATERIAL TYPE M.S/ S.S / ALUMINIUM POWDER COATED
HEIGHT 600 MM, 900MM, 1200 MM
MRP



PRODUCT CODE 1652 TISWA
POWER 10W, 15W,
CCT 3000K, 4000K, 6000K
MATERIAL TYPE M.S/ S.S / ALUMINIUM POWDER COATED
HEIGHT 600 MM, 900MM, 1200 MM
MRP



PRODUCT CODE 1653 EXTREME
POWER 10W, 15W,
CCT 3000K, 4000K, 6000K
MATERIAL TYPE M.S/ S.S / ALUMINIUM POWDER COATED
HEIGHT 600 MM, 900MM, 1200 MM
MRP



PRODUCT CODE 1654 SUPREME
POWER 10W, 15W,
CCT 3000K, 4000K, 6000K
MATERIAL TYPE M.S/ S.S / ALUMINIUM POWDER COATED
HEIGHT 600 MM, 900MM, 1200 MM
MRP



PRODUCT CODE 1661 SILSO
POWER 10W, 15W,
CCT 3000K, 4000K, 6000K
MATERIAL TYPE M.S/ S.S / ALUMINIUM POWDER COATED
HEIGHT 600 MM, 900MM, 1200 MM
MRP



PRODUCT CODE 1662 ENCLO
POWER 10W, 15W,
CCT 3000K, 4000K, 6000K
MATERIAL TYPE M.S/ S.S / ALUMINIUM POWDER COATED
HEIGHT 600 MM, 900MM, 1200 MM
MRP



PRODUCT CODE 1663 BENCHO
POWER 10W, 15W,
CCT 3000K, 4000K, 6000K
MATERIAL TYPE M.S/ S.S / ALUMINIUM POWDER COATED
HEIGHT 600 MM, 900MM, 1200 MM
MRP



PRODUCT CODE 1664 CAPO
POWER 10W, 15W,
CCT 3000K, 4000K, 6000K
MATERIAL TYPE M.S/ S.S / ALUMINIUM POWDER COATED
HEIGHT 600 MM, 900MM, 1200 MM
MRP



PRODUCT CODE 1665 KERBY
POWER 10W, 15W,
CCT 3000K, 4000K, 6000K
MATERIAL TYPE M.S/ S.S / ALUMINIUM POWDER COATED
HEIGHT 600 MM, 900MM, 1200 MM
MRP



PRODUCT CODE 1666 WALLE
POWER 10W, 15W,
CCT 3000K, 4000K, 6000K
MATERIAL TYPE M.S/ S.S / ALUMINIUM POWDER COATED
HEIGHT 600 MM, 900MM, 1200 MM
MRP



PRODUCT CODE 1673 KINGLY
POWER 5W, 7W, 9W,
CCT 3000K, 4000K, 6000K
MATERIAL TYPE M.S/ S.S / ALUMINIUM POWDER COATED
HEIGHT 600 MM, 900MM, 1200 MM
MRP



PRODUCT CODE 1674 QUEENLY
POWER 5W, 7W, 9W,
CCT 3000K, 4000K, 6000K
MATERIAL TYPE M.S/ S.S / ALUMINIUM POWDER COATED
HEIGHT 600 MM, 900MM, 1200 MM
MRP



PRODUCT CODE 1675 PRINCELY
POWER 5W, 7W, 9W,
CCT 3000K, 4000K, 6000K
MATERIAL TYPE M.S/ S.S / ALUMINIUM POWDER COATED
HEIGHT 600 MM, 900MM, 1200 MM
MRP



PRODUCT CODE 1667 APEX
POWER 10W, 15W,
CCT 3000K, 4000K, 6000K
MATERIAL TYPE M.S/ S.S / ALUMINIUM POWDER COATED
HEIGHT 600 MM, 900MM, 1200 MM
MRP



PRODUCT CODE 1668 APEX GLOW
POWER 10W, 15W,
CCT 3000K, 4000K, 6000K
MATERIAL TYPE M.S/ S.S / ALUMINIUM POWDER COATED
HEIGHT 600 MM, 900MM, 1200 MM
MRP



PRODUCT CODE 1669 SLANTY
POWER 10W, 15W,
CCT 3000K, 4000K, 6000K
MATERIAL TYPE M.S/ S.S / ALUMINIUM POWDER COATED
HEIGHT 600 MM, 900MM, 1200 MM
MRP



PRODUCT CODE 1676 REGAL
POWER 5W, 7W, 9W,
CCT 3000K, 4000K, 6000K
MATERIAL TYPE M.S/ S.S / ALUMINIUM POWDER COATED
HEIGHT 600 MM, 900MM, 1200 MM
MRP



PRODUCT CODE 1677 LAVISH
POWER 5W, 7W, 9W,
CCT 3000K, 4000K, 6000K
MATERIAL TYPE M.S/ S.S / ALUMINIUM POWDER COATED
HEIGHT 600 MM, 900MM, 1200 MM
MRP



PRODUCT CODE 1678 KILLER
POWER 5W, 7W, 9W,
CCT 3000K, 4000K, 6000K
MATERIAL TYPE M.S/ S.S / ALUMINIUM POWDER COATED
HEIGHT 600 MM, 900MM, 1200 MM
MRP



PRODUCT CODE 1670 HOCKEY
POWER 10W, 15W,
CCT 3000K, 4000K, 6000K
MATERIAL TYPE M.S/ S.S / ALUMINIUM POWDER COATED
HEIGHT 600 MM, 900MM, 1200 MM
MRP



PRODUCT CODE 1671 LIGHT PLANT
POWER 10W, 15W,
CCT 3000K, 4000K, 6000K
MATERIAL TYPE M.S/ S.S / ALUMINIUM POWDER COATED
HEIGHT 600 MM, 900MM, 1200 MM
MRP



PRODUCT CODE 1672 SAPTEM
POWER 10W, 15W,
CCT 3000K, 4000K, 6000K
MATERIAL TYPE M.S/ S.S / ALUMINIUM POWDER COATED
HEIGHT 600 MM, 900MM, 1200 MM
MRP



PRODUCT CODE 1679 TRIVIA
POWER 10W, 15W,
CCT 3000K, 4000K, 6000K
MATERIAL TYPE M.S/ S.S / ALUMINIUM POWDER COATED
HEIGHT 600 MM, 900MM, 1200 MM
MRP



PRODUCT CODE 1680 DIVINE
POWER 10W, 15W,
CCT 3000K, 4000K, 6000K
MATERIAL TYPE M.S/ S.S / ALUMINIUM POWDER COATED
HEIGHT 600 MM, 900MM, 1200 MM
MRP



PRODUCT CODE 1681 SUPERIO
POWER 10W, 15W,
CCT 3000K, 4000K, 6000K
MATERIAL TYPE M.S/ S.S / ALUMINIUM POWDER COATED
HEIGHT 600 MM, 900MM, 1200 MM
MRP



PRODUCT CODE 1682 ICONIC
POWER 10W, 15W,
CCT 3000K, 4000K, 6000K
MATERIAL TYPE M.S/ S.S / ALUMINIUM POWDER COATED
HEIGHT 600 MM, 900MM, 1200 MM
MRP



PRODUCT CODE 1683 CORAL
POWER 10W, 15W,
CCT 3000K, 4000K, 6000K
MATERIAL TYPE M.S/ S.S / ALUMINIUM POWDER COATED
HEIGHT 600 MM, 900MM, 1200 MM
MRP



PRODUCT CODE 1684 WOW
POWER 10W, 15W,
CCT 3000K, 4000K, 6000K
MATERIAL TYPE M.S/ S.S / ALUMINIUM POWDER COATED
HEIGHT 600 MM, 900MM, 1200 MM
MRP



PRODUCT CODE 1691 CANVAS
POWER 10W, 15W,
CCT 3000K, 4000K, 6000K
MATERIAL TYPE M.S/ S.S / ALUMINIUM POWDER COATED
HEIGHT 600 MM, 900MM, 1200 MM
MRP



PRODUCT CODE 1692 ZION
POWER 10W, 15W,
CCT 3000K, 4000K, 6000K
MATERIAL TYPE M.S/ S.S / ALUMINIUM POWDER COATED
HEIGHT 600 MM, 900MM, 1200 MM
MRP



PRODUCT CODE 1693 VELLOZ
POWER 10W, 15W,
CCT 3000K, 4000K, 6000K
MATERIAL TYPE M.S/ S.S / ALUMINIUM POWDER COATED
HEIGHT 600 MM, 900MM, 1200 MM
MRP



PRODUCT CODE 1685 VISTA
POWER 10W, 15W,
CCT 3000K, 4000K, 6000K
MATERIAL TYPE M.S/ S.S / ALUMINIUM POWDER COATED
HEIGHT 600 MM, 900MM, 1200 MM
MRP



PRODUCT CODE 1686 GREY MAN
POWER 10W, 15W,
CCT 3000K, 4000K, 6000K
MATERIAL TYPE M.S/ S.S / ALUMINIUM POWDER COATED
HEIGHT 600 MM, 900MM, 1200 MM
MRP



PRODUCT CODE 1687 ENGLAZE
POWER 10W, 15W,
CCT 3000K, 4000K, 6000K
MATERIAL TYPE M.S/ S.S / ALUMINIUM POWDER COATED
HEIGHT 600 MM, 900MM, 1200 MM
MRP



PRODUCT CODE 1694 ANTIKE
POWER 10W, 15W,
CCT 3000K, 4000K, 6000K
MATERIAL TYPE M.S/ S.S / ALUMINIUM POWDER COATED
HEIGHT 600 MM, 900MM, 1200 MM
MRP



PRODUCT CODE 1695 FOREST
POWER 10W, 15W,
CCT 3000K, 4000K, 6000K
MATERIAL TYPE M.S/ S.S / ALUMINIUM POWDER COATED
HEIGHT 600 MM, 900MM, 1200 MM
MRP



PRODUCT CODE 1696 MATRIX
POWER 10W, 15W,
CCT 3000K, 4000K, 6000K
MATERIAL TYPE M.S/ S.S / ALUMINIUM POWDER COATED
HEIGHT 600 MM, 900MM, 1200 MM
MRP



PRODUCT CODE 1688 DAZO
POWER 10W, 15W,
CCT 3000K, 4000K, 6000K
MATERIAL TYPE M.S/ S.S / ALUMINIUM POWDER COATED
HEIGHT 600 MM, 900MM, 1200 MM
MRP



PRODUCT CODE 1689 ORO
POWER 10W, 15W,
CCT 3000K, 4000K, 6000K
MATERIAL TYPE M.S/ S.S / ALUMINIUM POWDER COATED
HEIGHT 600 MM, 900MM, 1200 MM
MRP



PRODUCT CODE 1690 MEGNA
POWER 10W, 15W,
CCT 3000K, 4000K, 6000K
MATERIAL TYPE M.S/ S.S / ALUMINIUM POWDER COATED
HEIGHT 600 MM, 900MM, 1200 MM
MRP

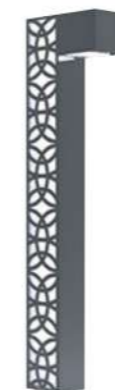

PRODUCT CODE 1697 NEXA
POWER 10W, 15W,
CCT 3000K, 4000K, 6000K
MATERIAL TYPE M.S/ S.S / ALUMINIUM POWDER COATED
HEIGHT 600 MM, 900MM, 1200 MM
MRP



PRODUCT CODE 1698 LEAFOR
POWER 10W, 15W,
CCT 3000K, 4000K, 6000K
MATERIAL TYPE M.S/ S.S / ALUMINIUM POWDER COATED
HEIGHT 600 MM, 900MM, 1200 MM
MRP



PRODUCT CODE 1699 META GOLD
POWER 10W, 15W,
CCT 3000K, 4000K, 6000K
MATERIAL TYPE M.S/ S.S / ALUMINIUM POWDER COATED
HEIGHT 600 MM, 900MM, 1200 MM
MRP

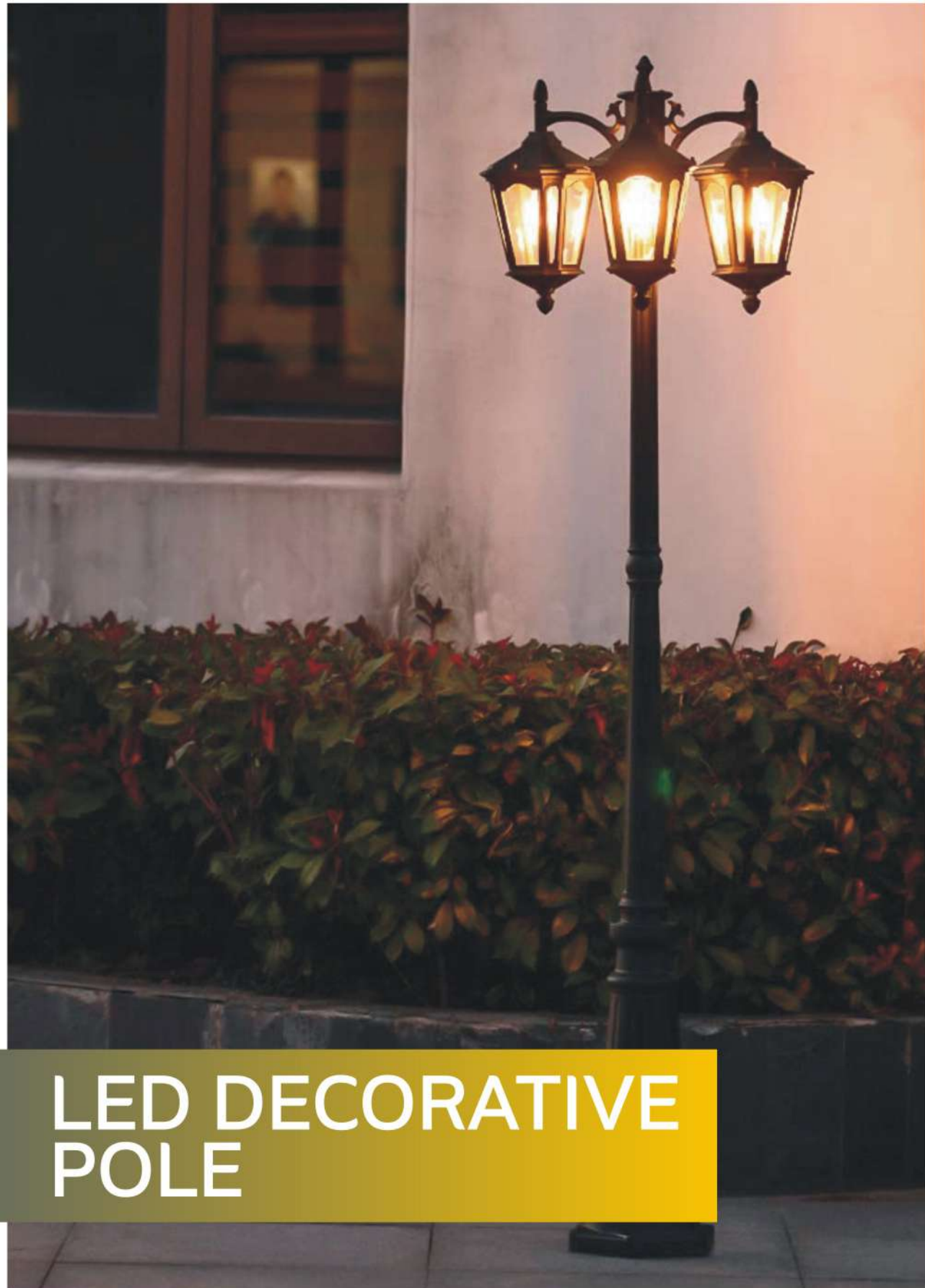

LED DECORATIVE POLE

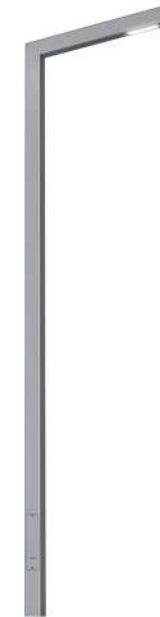

PRODUCT CODE 1701 - GAMA
POWER 30W, 50W, 100W
CCT 3000K, 6000K
MATERIAL TYPE M.S / ALUMINIUM POWDER COATED
HEIGHT

| | | |
|------|------|------|
| 10FT | 12FT | 15FT |
|------|------|------|

MRP

| | | |
|--|--|--|
| | | |
|--|--|--|



PRODUCT CODE 1702 - COBRA
POWER 30W, 50W, 100W
CCT 3000K, 6000K
MATERIAL TYPE M.S / ALUMINIUM POWDER COATED
HEIGHT

| | | |
|------|------|------|
| 10FT | 12FT | 15FT |
|------|------|------|

MRP

| | | |
|--|--|--|
| | | |
|--|--|--|

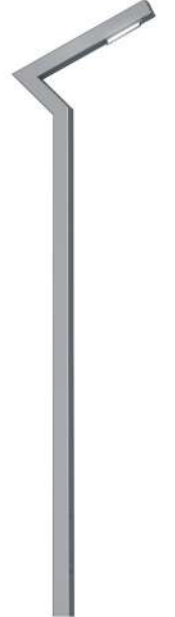

PRODUCT CODE 1703 - ZETA
POWER 30W, 50W, 100W
CCT 3000K, 6000K
MATERIAL TYPE M.S / ALUMINIUM POWDER COATED
HEIGHT

| | | |
|------|------|------|
| 10FT | 12FT | 15FT |
|------|------|------|

MRP

| | | |
|--|--|--|
| | | |
|--|--|--|

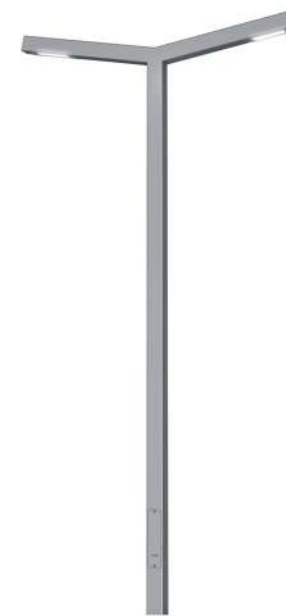

PRODUCT CODE 1704 - ANTENA
POWER 30W, 50W, 100W
CCT 3000K, 6000K
MATERIAL TYPE M.S / ALUMINIUM POWDER COATED
HEIGHT

| | | |
|------|------|------|
| 10FT | 12FT | 15FT |
|------|------|------|

MRP

| | | |
|--|--|--|
| | | |
|--|--|--|



PRODUCT CODE 1705 - EPSILON
POWER 30W, 50W, 100W
CCT 3000K, 6000K
MATERIAL TYPE M.S / ALUMINIUM POWDER COATED
HEIGHT

| | | |
|------|------|------|
| 10FT | 12FT | 15FT |
|------|------|------|

MRP

| | | |
|--|--|--|
| | | |
|--|--|--|



PRODUCT CODE 1706 - FENTA
POWER 30W, 50W, 100W
CCT 3000K, 6000K
MATERIAL TYPE M.S / ALUMINIUM POWDER COATED
HEIGHT

| | | |
|------|------|------|
| 10FT | 12FT | 15FT |
|------|------|------|

MRP

| | | |
|--|--|--|
| | | |
|--|--|--|



PRODUCT CODE 1707 - AERIAL
POWER 30W, 50W, 100W
CCT 3000K, 6000K
MATERIAL TYPE M.S / ALUMINIUM POWDER COATED
HEIGHT

| | | |
|------|------|------|
| 10FT | 12FT | 15FT |
|------|------|------|

MRP

| | | |
|--|--|--|
| | | |
|--|--|--|

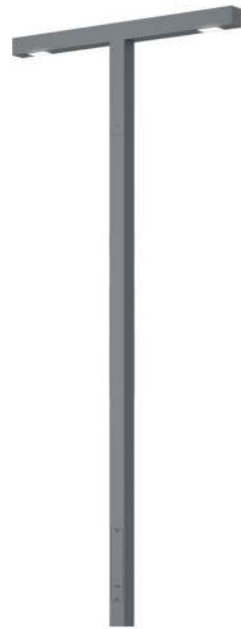

PRODUCT CODE 1708 - TAU
POWER 30W, 50W, 100W
CCT 3000K, 6000K
MATERIAL TYPE M.S / ALUMINIUM POWDER COATED
HEIGHT

| | | |
|------|------|------|
| 10FT | 12FT | 15FT |
|------|------|------|

MRP

| | | |
|--|--|--|
| | | |
|--|--|--|



PRODUCT CODE 1709 - LAMDA
POWER 30W, 50W, 100W
CCT 3000K, 6000K
MATERIAL TYPE M.S / ALUMINIUM POWDER COATED
HEIGHT

| | | |
|------|------|------|
| 10FT | 12FT | 15FT |
|------|------|------|

MRP

| | | |
|--|--|--|
| | | |
|--|--|--|



PRODUCT CODE 1713 - VERTICA
POWER 20W, 24W, 36W
CCT 3000K, 6000K
MATERIAL TYPE M.S / ALUMINIUM POWDER COATED
HEIGHT

| | | | |
|------|------|------|------|
| 08FT | 10FT | 12FT | 15FT |
|------|------|------|------|

MRP

| | | | |
|--|--|--|--|
| | | | |
|--|--|--|--|



PRODUCT CODE 1714 - SQUARECUT
POWER 20W, 24W, 36W
CCT 3000K, 4000K
MATERIAL TYPE M.S / ALUMINIUM POWDER COATED
HEIGHT

| | | | |
|------|------|------|------|
| 08FT | 10FT | 12FT | 15FT |
|------|------|------|------|

MRP

| | | | |
|--|--|--|--|
| | | | |
|--|--|--|--|



PRODUCT CODE 1715 - QUADRA
POWER 20W, 24W, 36W
CCT 3000K, 6000K
MATERIAL TYPE M.S / ALUMINIUM POWDER COATED
HEIGHT

| | | | |
|------|------|------|------|
| 08FT | 10FT | 12FT | 15FT |
|------|------|------|------|

MRP

| | | | |
|--|--|--|--|
| | | | |
|--|--|--|--|



PRODUCT CODE 1710 - PAI
POWER 30W, 50W, 100W
CCT 3000K, 6000K
MATERIAL TYPE M.S / ALUMINIUM POWDER COATED
HEIGHT

| | | |
|------|------|------|
| 10FT | 12FT | 15FT |
|------|------|------|

MRP

| | | |
|--|--|--|
| | | |
|--|--|--|

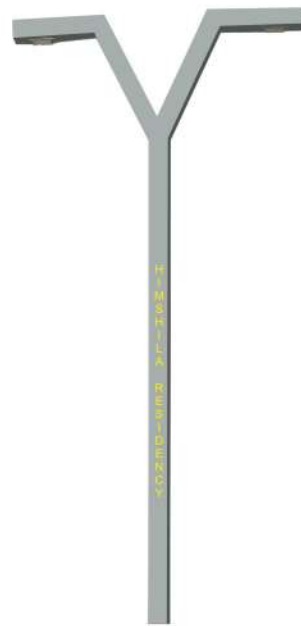

PRODUCT CODE 1711 - EPSILON GLOW
POWER 30W, 50W, 100W
CCT 3000K, 6000K
MATERIAL TYPE M.S / ALUMINIUM POWDER COATED
HEIGHT

| | | |
|------|------|------|
| 10FT | 12FT | 15FT |
|------|------|------|

MRP

| | | |
|--|--|--|
| | | |
|--|--|--|



PRODUCT CODE 1712 - ZIG-ZAG
POWER 30W, 50W, 100W
CCT 3000K, 6000K
MATERIAL TYPE M.S / ALUMINIUM POWDER COATED
HEIGHT

| | | |
|------|------|------|
| 10FT | 12FT | 15FT |
|------|------|------|

MRP

| | | |
|--|--|--|
| | | |
|--|--|--|



PRODUCT CODE 1716 - SLEEKY
POWER 20W, 24W, 36W
CCT 3000K, 6000K
MATERIAL TYPE M.S / ALUMINIUM POWDER COATED
HEIGHT

| | | | |
|------|------|------|------|
| 08FT | 10FT | 12FT | 15FT |
|------|------|------|------|

MRP

| | | | |
|--|--|--|--|
| | | | |
|--|--|--|--|



PRODUCT CODE 1717 - TREMY
POWER 20W, 24W, 36W
CCT 3000K, 6000K
MATERIAL TYPE M.S / ALUMINIUM POWDER COATED
HEIGHT

| | | | |
|------|------|------|------|
| 08FT | 10FT | 12FT | 15FT |
|------|------|------|------|

MRP

| | | | |
|--|--|--|--|
| | | | |
|--|--|--|--|

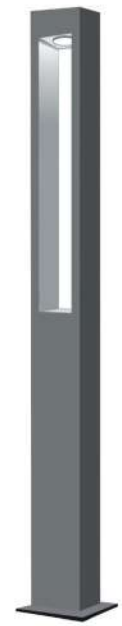

PRODUCT CODE 1718 - SPLITY
POWER 20W, 24W, 36W
CCT 3000K, 6000K
MATERIAL TYPE M.S / ALUMINIUM POWDER COATED
HEIGHT

| | | | |
|------|------|------|------|
| 08FT | 10FT | 12FT | 15FT |
|------|------|------|------|

MRP

| | | | |
|--|--|--|--|
| | | | |
|--|--|--|--|

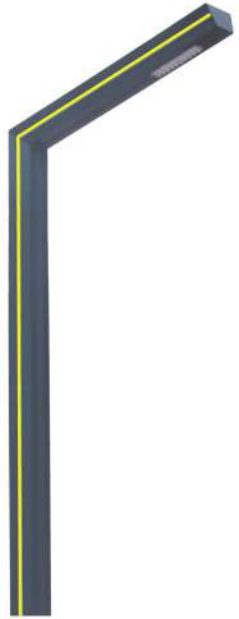

PRODUCT CODE 1719 - GAMA PRO
POWER 30W, 50W, 100W
CCT 3000K, 6000K
MATERIAL TYPE M.S / ALUMINIUM POWDER COATED
HEIGHT

| | | |
|------|------|------|
| 10FT | 12FT | 15FT |
|------|------|------|

MRP

| | | |
|--|--|--|
| | | |
|--|--|--|

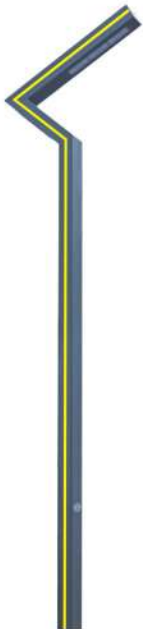

PRODUCT CODE 1720 - ZETA PRO
POWER 30W, 50W, 100W
CCT 3000K, 6000K
MATERIAL TYPE M.S / ALUMINIUM POWDER COATED
HEIGHT

| | | |
|------|------|------|
| 10FT | 12FT | 15FT |
|------|------|------|

MRP

| | | |
|--|--|--|
| | | |
|--|--|--|



PRODUCT CODE 1721 - ANTENA PRO
POWER 30W, 50W, 100W
CCT 3000K, 6000K
MATERIAL TYPE M.S / ALUMINIUM POWDER COATED
HEIGHT

| | | |
|------|------|------|
| 10FT | 12FT | 15FT |
|------|------|------|

MRP

| | | |
|--|--|--|
| | | |
|--|--|--|



PRODUCT CODE 1725 - TREBLE PRO
POWER 30W, 50W, 100W
CCT 3000K, 6000K
MATERIAL TYPE M.S / ALUMINIUM POWDER COATED
HEIGHT

| | | |
|------|------|------|
| 10FT | 12FT | 15FT |
|------|------|------|

MRP

| | | |
|--|--|--|
| | | |
|--|--|--|



PRODUCT CODE 1726 - DIAMOND PRO
POWER 30W, 50W, 100W
CCT 3000K, 6000K
MATERIAL TYPE M.S / ALUMINIUM POWDER COATED
HEIGHT

| | | |
|------|------|------|
| 10FT | 12FT | 15FT |
|------|------|------|

MRP

| | | |
|--|--|--|
| | | |
|--|--|--|



PRODUCT CODE 1727 - TOPAZ PRO
POWER 30W, 50W, 100W
CCT 3000K, 6000K
MATERIAL TYPE M.S / ALUMINIUM POWDER COATED
HEIGHT

| | | |
|------|------|------|
| 10FT | 12FT | 15FT |
|------|------|------|

MRP

| | | |
|--|--|--|
| | | |
|--|--|--|

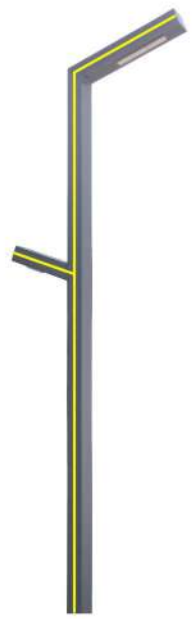

PRODUCT CODE 1722 - FENTA PRO
POWER 30W, 50W, 100W
CCT 3000K, 6000K
MATERIAL TYPE M.S / ALUMINIUM POWDER COATED
HEIGHT

| | | |
|------|------|------|
| 10FT | 12FT | 15FT |
|------|------|------|

MRP

| | | |
|--|--|--|
| | | |
|--|--|--|

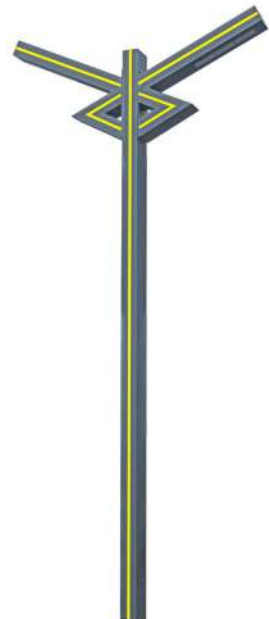

PRODUCT CODE 1723 - TRIDENT PRO
POWER 30W, 50W, 100W
CCT 3000K, 6000K
MATERIAL TYPE M.S / ALUMINIUM POWDER COATED
HEIGHT

| | | |
|------|------|------|
| 10FT | 12FT | 15FT |
|------|------|------|

MRP

| | | |
|--|--|--|
| | | |
|--|--|--|

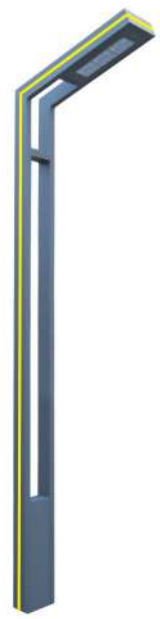

PRODUCT CODE 1724 GAMA PROUD
POWER 30W, 50W, 100W
CCT 3000K, 6000K
MATERIAL TYPE M.S / ALUMINIUM POWDER COATED
HEIGHT

| | | |
|------|------|------|
| 10FT | 12FT | 15FT |
|------|------|------|

MRP

| | | |
|--|--|--|
| | | |
|--|--|--|



PRODUCT CODE 1728 - WICKET PRO
POWER 30W, 50W, 100W
CCT 3000K, 6000K
MATERIAL TYPE M.S / ALUMINIUM POWDER COATED
HEIGHT

| | | |
|------|------|------|
| 10FT | 12FT | 15FT |
|------|------|------|

MRP

| | | |
|--|--|--|
| | | |
|--|--|--|

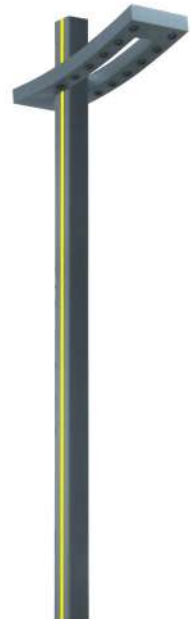

PRODUCT CODE 1729 - OBLONG PRO
POWER 30W, 50W, 100W
CCT 3000K, 6000K
MATERIAL TYPE M.S / ALUMINIUM POWDER COATED
HEIGHT

| | | |
|------|------|------|
| 10FT | 12FT | 15FT |
|------|------|------|

MRP

| | | |
|--|--|--|
| | | |
|--|--|--|



PRODUCT CODE 1730 - HEXA PRO
POWER 30W, 50W, 100W
CCT 3000K, 6000K
MATERIAL TYPE M.S / ALUMINIUM POWDER COATED
HEIGHT

| | | |
|------|------|------|
| 10FT | 12FT | 15FT |
|------|------|------|

MRP

| | | |
|--|--|--|
| | | |
|--|--|--|



PRODUCT CODE 1731 - TRIGON
POWER 24W, 36W, 50W
CCT 3000K, 6000K
MATERIAL TYPE M.S / ALUMINIUM POWDER COATED
HEIGHT

| | | |
|------|------|------|
| 10FT | 12FT | 15FT |
|------|------|------|

MRP

| | | |
|--|--|--|
| | | |
|--|--|--|

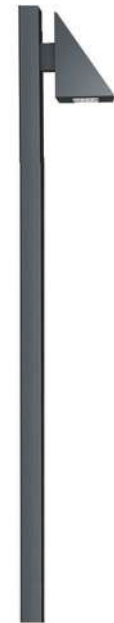

PRODUCT CODE 1732 - CUNESH
POWER 24W, 36W, 50W
CCT 3000K, 6000K
MATERIAL TYPE M.S / ALUMINIUM POWDER COATED
HEIGHT

| | | |
|------|------|------|
| 10FT | 12FT | 15FT |
|------|------|------|

MRP

| | | |
|--|--|--|
| | | |
|--|--|--|



PRODUCT CODE 1733 - SQUIRCLE
POWER 24W, 36W, 50W
CCT 3000K, 6000K
MATERIAL TYPE M.S / ALUMINIUM POWDER COATED
HEIGHT

| | | |
|------|------|------|
| 10FT | 12FT | 15FT |
|------|------|------|

MRP

| | | |
|--|--|--|
| | | |
|--|--|--|



PRODUCT CODE 1737 - VICTOR
POWER 24W, 36W, 50W
CCT 3000K, 6000K
MATERIAL TYPE M.S / ALUMINIUM POWDER COATED
HEIGHT

| | | |
|------|------|------|
| 10FT | 12FT | 15FT |
|------|------|------|

MRP

| | | |
|--|--|--|
| | | |
|--|--|--|

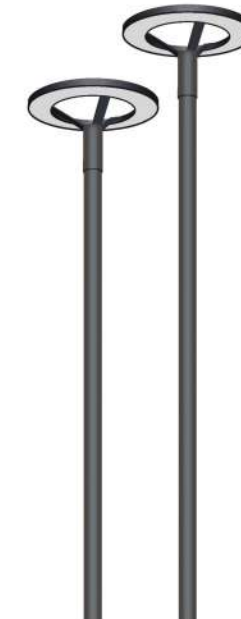

PRODUCT CODE 1738 - PHILIPA
POWER 24W, 36W, 50W
CCT 3000K, 6000K
MATERIAL TYPE M.S / ALUMINIUM POWDER COATED
HEIGHT

| | | |
|------|------|------|
| 10FT | 12FT | 15FT |
|------|------|------|

MRP

| | | |
|--|--|--|
| | | |
|--|--|--|



PRODUCT CODE 1739 - INFINITY
POWER 24W, 36W, 50W
CCT 3000K, 6000K
MATERIAL TYPE M.S / ALUMINIUM POWDER COATED
HEIGHT

| | | |
|------|------|------|
| 10FT | 12FT | 15FT |
|------|------|------|

MRP

| | | |
|--|--|--|
| | | |
|--|--|--|



PRODUCT CODE 1734 - DRUM
POWER 24W, 36W, 50W
CCT 3000K, 6000K
MATERIAL TYPE M.S / ALUMINIUM POWDER COATED
HEIGHT

| | | |
|------|------|------|
| 10FT | 12FT | 15FT |
|------|------|------|

MRP

| | | |
|--|--|--|
| | | |
|--|--|--|



PRODUCT CODE 1735 - MARROW
POWER 24W, 36W, 50W
CCT 3000K, 6000K
MATERIAL TYPE M.S / ALUMINIUM POWDER COATED
HEIGHT

| | | |
|------|------|------|
| 10FT | 12FT | 15FT |
|------|------|------|

MRP

| | | |
|--|--|--|
| | | |
|--|--|--|



PRODUCT CODE 1736 - LUCID
POWER 20W, 24W, 36W
CCT 3000K, 6000K
MATERIAL TYPE M.S / ALUMINIUM POWDER COATED
HEIGHT

| | | |
|------|------|------|
| 10FT | 12FT | 15FT |
|------|------|------|

MRP

| | | |
|--|--|--|
| | | |
|--|--|--|



PRODUCT CODE 1740 - MASHROOM
POWER 24W, 36W, 50W
CCT 3000K, 6000K
MATERIAL TYPE M.S / ALUMINIUM POWDER COATED
HEIGHT

| | | |
|------|------|------|
| 10FT | 12FT | 15FT |
|------|------|------|

MRP

| | | |
|--|--|--|
| | | |
|--|--|--|



NAME 1741 - WAVE
PRODUCT CODE 24W, 36W, 50W
POWER 3000K, 6000K
CCT M.S / ALUMINIUM POWDER COATED
MATERIAL TYPE

| | | |
|------|------|------|
| 10FT | 12FT | 15FT |
|------|------|------|

DIMENSION

| | | |
|--|--|--|
| | | |
|--|--|--|



PRODUCT CODE 1742 - BEACON
POWER 24W, 36W, 50W
CCT 3000K, 6000K
MATERIAL TYPE M.S / ALUMINIUM POWDER COATED
HEIGHT

| | | |
|------|------|------|
| 10FT | 12FT | 15FT |
|------|------|------|

MRP

| | | |
|--|--|--|
| | | |
|--|--|--|



PRODUCT CODE 1743 - LENTERN
POWER 20W, 24W, 36W, 50W
CCT 3000K, 6000K
MATERIAL TYPE M.S / ALUMINIUM POWDER COATED
HEIGHT

| | | |
|------|------|------|
| 10FT | 12FT | 15FT |
| | | |

MRP



PRODUCT CODE 1744 - ROYAL
POWER 20W, 24W, 36W, 50W
CCT 3000K, 6000K
MATERIAL TYPE M.S / ALUMINIUM POWDER COATED
HEIGHT

| | | |
|------|------|------|
| 10FT | 12FT | 15FT |
| | | |

MRP



PRODUCT CODE 1745 - CROWN
POWER 20W, 24W, 36W, 50W
CCT 3000K, 6000K
MATERIAL TYPE M.S / ALUMINIUM POWDER COATED
HEIGHT

| | | |
|------|------|------|
| 10FT | 12FT | 15FT |
| | | |

MRP



PRODUCT CODE 1749 - GRAMO
POWER 20W, 24W, 36W, 50W
CCT 3000K, 6000K
MATERIAL TYPE M.S / ALUMINIUM POWDER COATED
HEIGHT

| | | |
|------|------|------|
| 10FT | 12FT | 15FT |
| | | |

MRP



PRODUCT CODE 1750 - LEAFY
POWER 30W, 50W, 100W
CCT 3000K, 6000K
MATERIAL TYPE M.S / ALUMINIUM POWDER COATED
HEIGHT

| | | |
|------|------|------|
| 10FT | 12FT | 15FT |
| | | |

MRP



PRODUCT CODE 1751 - BERRIES
POWER 30W, 50W, 100W
CCT 3000K, 6000K
MATERIAL TYPE M.S / ALUMINIUM POWDER COATED
HEIGHT

| | | |
|------|------|------|
| 10FT | 12FT | 15FT |
| | | |

MRP



PRODUCT CODE 1746 - PALM
POWER 20W, 24W, 36W, 50W
CCT 3000K, 6000K
MATERIAL TYPE M.S / ALUMINIUM POWDER COATED
HEIGHT

| | | |
|------|------|------|
| 10FT | 12FT | 15FT |
| | | |

MRP



PRODUCT CODE 1747 - CAMLIN
POWER 20W, 24W, 36W, 50W
CCT 3000K, 6000K
MATERIAL TYPE M.S / ALUMINIUM POWDER COATED
HEIGHT

| | | |
|------|------|------|
| 10FT | 12FT | 15FT |
| | | |

MRP



PRODUCT CODE 1748 - OPTICONE
POWER 20W, 24W, 36W, 50W
CCT 3000K, 6000K
MATERIAL TYPE M.S / ALUMINIUM POWDER COATED
HEIGHT

| | | |
|------|------|------|
| 10FT | 12FT | 15FT |
| | | |

MRP

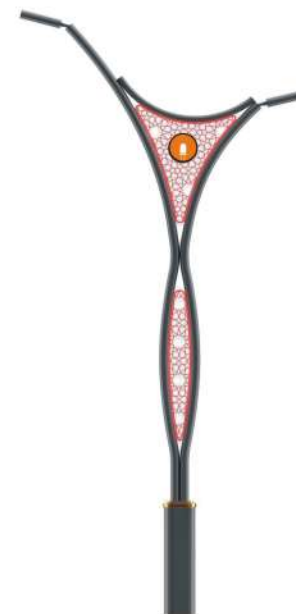

PRODUCT CODE 1752 - DNA
POWER 30W, 50W, 100W
CCT 3000K, 6000K
MATERIAL TYPE M.S / ALUMINIUM POWDER COATED
HEIGHT

| | | |
|------|------|------|
| 10FT | 12FT | 15FT |
| | | |

MRP



PRODUCT CODE 1753 - VAYA
POWER 30W, 50W, 100W
CCT 3000K, 6000K
MATERIAL TYPE M.S / ALUMINIUM POWDER COATED
HEIGHT

| | | |
|------|------|------|
| 10FT | 12FT | 15FT |
| | | |

MRP



PRODUCT CODE 1754 - CASISTA
POWER 30W, 50W, 100W
CCT 3000K, 6000K
MATERIAL TYPE M.S / ALUMINIUM POWDER COATED
HEIGHT

| | | |
|------|------|------|
| 10FT | 12FT | 15FT |
| | | |

MRP



PRODUCT CODE 1755 - EXENDRA
POWER 20W, 24W, 36W
CCT 3000K, 6000K
MATERIAL TYPE M.S / ALUMINIUM POWDER COATED
HEIGHT

| | | |
|------|------|------|
| 10FT | 12FT | 15FT |
|------|------|------|

MRP

| | | |
|--|--|--|
| | | |
|--|--|--|



PRODUCT CODE 1756 - ROMAN ROUND
POWER 20W, 24W, 36W
CCT 3000K, 6000K
MATERIAL TYPE M.S / ALUMINIUM POWDER COATED
HEIGHT

| | | |
|------|------|------|
| 10FT | 12FT | 15FT |
|------|------|------|

MRP

| | | |
|--|--|--|
| | | |
|--|--|--|



PRODUCT CODE 1757 - BLOSSOM
POWER 20W, 24W, 36W
CCT 3000K, 6000K
MATERIAL TYPE M.S / ALUMINIUM POWDER COATED
HEIGHT

| | | |
|------|------|------|
| 10FT | 12FT | 15FT |
|------|------|------|

MRP

| | | |
|--|--|--|
| | | |
|--|--|--|

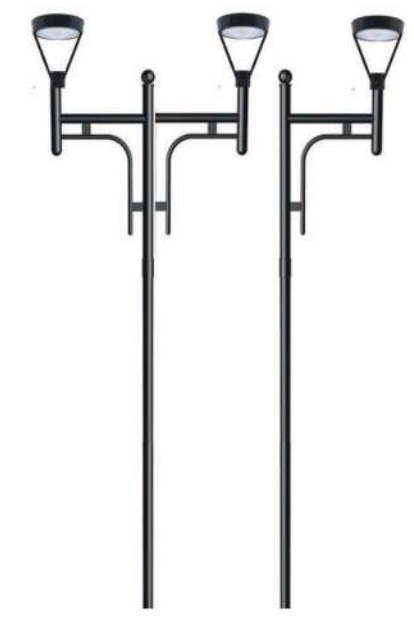

PRODUCT CODE 1761 - SIGNIFI
POWER 24W, 36W, 50W
CCT 3000K, 6000K
MATERIAL TYPE M.S / ALUMINIUM POWDER COATED
HEIGHT

| | | |
|------|------|------|
| 10FT | 12FT | 15FT |
|------|------|------|

MRP

| | | |
|--|--|--|
| | | |
|--|--|--|



PRODUCT CODE 1762 - EMPIRE
POWER 20W, 24W, 36W,
CCT 3000K, 6000K
MATERIAL TYPE M.S / ALUMINIUM POWDER COATED
HEIGHT

| | | |
|------|------|------|
| 10FT | 12FT | 15FT |
|------|------|------|

MRP

| | | |
|--|--|--|
| | | |
|--|--|--|



PRODUCT CODE 1763 - PEACOCK
POWER 20W, 24W, 36W
CCT 3000K, 6000K
MATERIAL TYPE M.S / ALUMINIUM POWDER COATED
HEIGHT

| | | |
|------|------|------|
| 10FT | 12FT | 15FT |
|------|------|------|

MRP

| | | |
|--|--|--|
| | | |
|--|--|--|



PRODUCT CODE 1758 - EAGLE
POWER 20W, 24W, 36W
CCT 3000K, 6000K
MATERIAL TYPE M.S / ALUMINIUM POWDER COATED
HEIGHT

| | | |
|------|------|------|
| 10FT | 12FT | 15FT |
|------|------|------|

MRP

| | | |
|--|--|--|
| | | |
|--|--|--|



PRODUCT CODE 1759 - FIESTA
POWER 20W, 24W, 36W
CCT 3000K, 6000K
MATERIAL TYPE M.S / ALUMINIUM POWDER COATED
HEIGHT

| | | |
|------|------|------|
| 10FT | 12FT | 15FT |
|------|------|------|

MRP

| | | |
|--|--|--|
| | | |
|--|--|--|



PRODUCT CODE 1760 - HALMENTA
POWER 20W, 24W, 36W
CCT 3000K, 6000K
MATERIAL TYPE M.S / ALUMINIUM POWDER COATED
HEIGHT

| | | |
|------|------|------|
| 10FT | 12FT | 15FT |
|------|------|------|

MRP

| | | |
|--|--|--|
| | | |
|--|--|--|



PRODUCT CODE 1764 - CLASSIQUE
POWER 24W, 36W, 50W
CCT 3000K, 6000K
MATERIAL TYPE M.S / ALUMINIUM POWDER COATED
HEIGHT

| | | |
|------|------|------|
| 10FT | 12FT | 15FT |
|------|------|------|

MRP

| | | |
|--|--|--|
| | | |
|--|--|--|



PRODUCT CODE 1765 - EURO
POWER 24W, 36W, 50W
CCT 3000K, 6000K
MATERIAL TYPE M.S / ALUMINIUM POWDER COATED
HEIGHT

| | | |
|------|------|------|
| 10FT | 12FT | 15FT |
|------|------|------|

MRP

| | | |
|--|--|--|
| | | |
|--|--|--|



PRODUCT CODE 1766 - PELICAN
POWER 24W, 36W, 50W
CCT 3000K, 6000K
MATERIAL TYPE M.S / ALUMINIUM POWDER COATED
HEIGHT

| | | |
|------|------|------|
| 10FT | 12FT | 15FT |
|------|------|------|

MRP

| | | |
|--|--|--|
| | | |
|--|--|--|



PRODUCT CODE 1767 - FENNEL
POWER 30W, 50W, 100W
CCT 3000K, 6000K
MATERIAL TYPE M.S / ALUMINIUM POWDER COATED
HEIGHT

| | | | |
|------|------|------|------|
| 08FT | 10FT | 12FT | 15FT |
| | | | |

MRP



PRODUCT CODE 1768 - FLORAL
POWER 30W, 50W, 100W
CCT 3000K, 6000K
MATERIAL TYPE M.S / ALUMINIUM POWDER COATED
HEIGHT

| | | | |
|------|------|------|------|
| 08FT | 10FT | 12FT | 15FT |
| | | | |

MRP



PRODUCT CODE 1769 - FORUS
POWER 30W, 50W, 100W
CCT 3000K, 6000K
MATERIAL TYPE M.S / ALUMINIUM POWDER COATED
HEIGHT

| | | | |
|------|------|------|------|
| 08FT | 10FT | 12FT | 15FT |
| | | | |

MRP



PRODUCT CODE 1773 - LIGHT BOX
POWER 30W, 50W, 100W
CCT 3000K, 6000K
MATERIAL TYPE M.S / ALUMINIUM POWDER COATED
HEIGHT

| | | | |
|------|------|------|------|
| 08FT | 10FT | 12FT | 15FT |
| | | | |

MRP



PRODUCT CODE 1774 - BUBBLE
POWER 30W, 50W, 100W
CCT 3000K, 6000K
MATERIAL TYPE M.S / ALUMINIUM POWDER COATED
HEIGHT

| | | | |
|------|------|------|------|
| 08FT | 10FT | 12FT | 15FT |
| | | | |

MRP



PRODUCT CODE 1775 - PROTOSTAR
POWER 30W, 50W, 100W
CCT 3000K, 6000K
MATERIAL TYPE M.S / ALUMINIUM POWDER COATED
HEIGHT

| | | | |
|------|------|------|------|
| 08FT | 10FT | 12FT | 15FT |
| | | | |

MRP



PRODUCT CODE 1770 - TWINKLE
POWER 30W, 50W, 100W
CCT 3000K, 6000K
MATERIAL TYPE M.S / ALUMINIUM POWDER COATED
HEIGHT

| | | | |
|------|------|------|------|
| 08FT | 10FT | 12FT | 15FT |
| | | | |

MRP



PRODUCT CODE 1771 - ARTVENDA
POWER 30W, 50W, 100W
CCT 3000K, 6000K
MATERIAL TYPE M.S / ALUMINIUM POWDER COATED
HEIGHT

| | | | |
|------|------|------|------|
| 08FT | 10FT | 12FT | 15FT |
| | | | |

MRP



PRODUCT CODE 1772 - ATOM
POWER 30W, 50W, 100W
CCT 3000K, 6000K
MATERIAL TYPE M.S / ALUMINIUM POWDER COATED
HEIGHT

| | | | |
|------|------|------|------|
| 08FT | 10FT | 12FT | 15FT |
| | | | |

MRP



PRODUCT CODE 1776 - STONE
POWER 20W, 24W, 36W, 50W
CCT 3000K, 6000K
MATERIAL TYPE M.S / ALUMINIUM POWDER COATED
HEIGHT

| | | | |
|------|------|------|------|
| 08FT | 10FT | 12FT | 15FT |
| | | | |

MRP



PRODUCT CODE 1777 - CLUB
POWER 20W, 24W, 36W, 50W
CCT 3000K, 6000K
MATERIAL TYPE M.S / ALUMINIUM POWDER COATED
HEIGHT

| | | | |
|------|------|------|------|
| 08FT | 10FT | 12FT | 15FT |
| | | | |

MRP



PRODUCT CODE 1778 - CORCUS
POWER 20W, 24W, 36W, 50W
CCT 3000K, 6000K
MATERIAL TYPE M.S / ALUMINIUM POWDER COATED
HEIGHT

| | | | |
|------|------|------|------|
| 08FT | 10FT | 12FT | 15FT |
| | | | |

MRP



PRODUCT CODE 1779 - EPOCH
POWER 20W, 24W, 36W, 50W
CCT 3000K, 6000K
MATERIAL TYPE C.I. / ALUMINIUM POWDER COATED
HEIGHT

| | | |
|------|------|------|
| 10FT | 12FT | 15FT |
| | | |

MRP



PRODUCT CODE 1780 - VEGAS
POWER 20W, 24W, 36W, 50W
CCT 3000K, 6000K
MATERIAL TYPE C.I. / ALUMINIUM POWDER COATED
HEIGHT

| | | |
|------|------|------|
| 10FT | 12FT | 15FT |
| | | |

MRP



PRODUCT CODE 1781 - PRAYAG
POWER 20W, 24W, 36W, 50W
CCT 3000K, 6000K
MATERIAL TYPE C.I. / ALUMINIUM POWDER COATED
HEIGHT

| | | |
|------|------|------|
| 10FT | 12FT | 15FT |
| | | |

MRP



PRODUCT CODE 1785 - ANCHORAGE
POWER 20W, 24W, 36W, 50W
CCT 3000K, 6000K
MATERIAL TYPE C.I. / ALUMINIUM POWDER COATED
HEIGHT

| | | |
|------|------|------|
| 10FT | 12FT | 15FT |
| | | |

MRP



PRODUCT CODE 1786 - MANRESA
POWER 20W, 24W, 36W, 50W
CCT 3000K, 6000K
MATERIAL TYPE C.I. / ALUMINIUM POWDER COATED
HEIGHT

| | | |
|------|------|------|
| 10FT | 12FT | 15FT |
| | | |

MRP



PRODUCT CODE 1787 - PARIS
POWER 20W, 24W, 36W, 50W
CCT 3000K, 6000K
MATERIAL TYPE C.I. / ALUMINIUM POWDER COATED
HEIGHT

| | | |
|------|------|------|
| 10FT | 12FT | 15FT |
| | | |

MRP



PRODUCT CODE 1782 - KASHI
POWER 20W, 24W, 36W, 50W
CCT 3000K, 6000K
MATERIAL TYPE C.I. / ALUMINIUM POWDER COATED
HEIGHT

| | | |
|------|------|------|
| 10FT | 12FT | 15FT |
| | | |

MRP



PRODUCT CODE 1783 - ROME
POWER 20W, 24W, 36W, 50W
CCT 3000K, 6000K
MATERIAL TYPE C.I. / ALUMINIUM POWDER COATED
HEIGHT

| | | |
|------|------|------|
| 10FT | 12FT | 15FT |
| | | |

MRP



PRODUCT CODE 1784 - VENICE
POWER 20W, 24W, 36W, 50W
CCT 3000K, 6000K
MATERIAL TYPE C.I. / ALUMINIUM POWDER COATED
HEIGHT

| | | |
|------|------|------|
| 10FT | 12FT | 15FT |
| | | |

MRP



PRODUCT CODE 1788 - WARSAW
POWER 20W, 24W, 36W, 50W
CCT 3000K, 6000K
MATERIAL TYPE C.I. / ALUMINIUM POWDER COATED
HEIGHT

| | | |
|------|------|------|
| 10FT | 12FT | 15FT |
| | | |

MRP



PRODUCT CODE 1789 - BUFFALO
POWER 20W, 24W, 36W, 50W
CCT 3000K, 6000K
MATERIAL TYPE C.I. / ALUMINIUM POWDER COATED
HEIGHT

| | | |
|------|------|------|
| 10FT | 12FT | 15FT |
| | | |

MRP



PRODUCT CODE 1790 - AURORA
POWER 20W, 24W, 36W, 50W
CCT 3000K, 6000K
MATERIAL TYPE C.I. / ALUMINIUM POWDER COATED
HEIGHT

| | | |
|------|------|------|
| 10FT | 12FT | 15FT |
| | | |

MRP

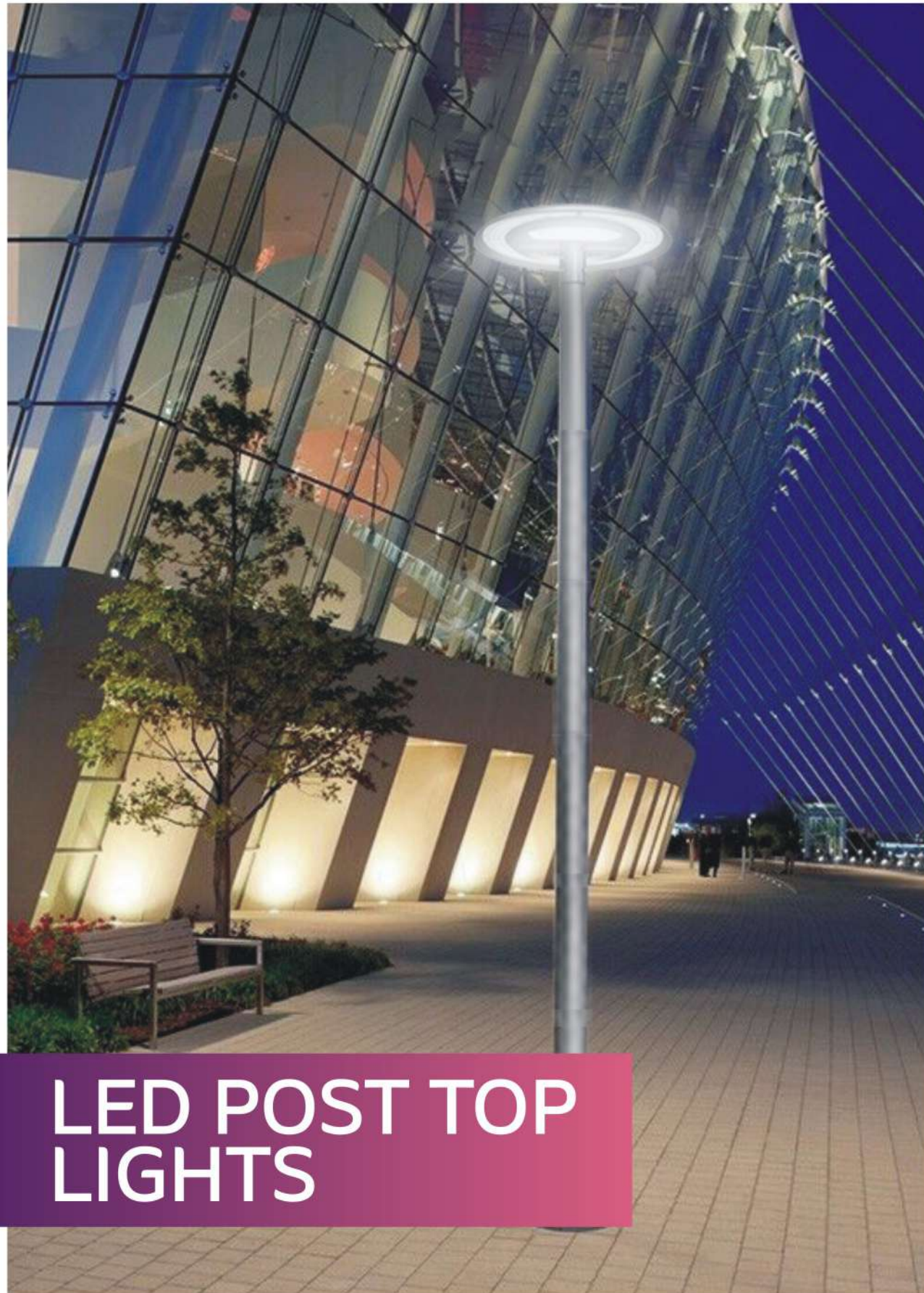

LED POST TOP LIGHTS



PRODUCT CODE 1901-PHILIPA-TOP
POWER 36W, 50W
CCT 3000K, 4000K, 6000K
MATERIAL TYPE ALUMINIUM POWDER COATED
DIMENSION
MRP



PRODUCT CODE 1902-LUNA
POWER 36W, 50W
CCT 3000K, 4000K, 6000K
MATERIAL TYPE ALUMINIUM POWDER COATED
DIMENSION
MRP



PRODUCT CODE 1903-PERABOLA
POWER 36W, 50W
CCT 3000K, 4000K, 6000K
MATERIAL TYPE ALUMINIUM POWDER COATED
DIMENSION
MRP



PRODUCT CODE 1904-VICTORIA
POWER 36W, 50W
CCT 3000K, 4000K, 6000K
MATERIAL TYPE ALUMINIUM POWDER COATED
DIMENSION
MRP



PRODUCT CODE 1905-VYOMA
POWER 36W, 50W
CCT 3000K, 4000K, 6000K
MATERIAL TYPE ALUMINIUM POWDER COATED
DIMENSION
MRP



PRODUCT CODE 1906-SAGA
POWER 36W, 50W
CCT 3000K, 4000K, 6000K
MATERIAL TYPE ALUMINIUM POWDER COATED
DIMENSION
MRP



PRODUCT CODE 1907-VEGA
POWER 36W, 50W
CCT 3000K, 4000K, 6000K
MATERIAL TYPE ALUMINIUM POWDER COATED
DIMENSION
MRP



PRODUCT CODE 1908-TOURAS
POWER 36W, 50W
CCT 3000K, 4000K, 6000K
MATERIAL TYPE ALUMINIUM POWDER COATED
DIMENSION
MRP



PRODUCT CODE 1909-INFINITY
POWER 36W X 2, 50W X 2
CCT 3000K, 4000K, 6000K
MATERIAL TYPE ALUMINIUM POWDER COATED
DIMENSION
MRP



PRODUCT CODE 1910-REFLEXO ROUND
POWER 36W, 50W
CCT 3000K, 4000K, 6000K
MATERIAL TYPE ALUMINIUM POWDER COATED
DIMENSION
MRP



PRODUCT CODE 1911-REFLEXO ELLIPES
POWER 36W, 50W
CCT 3000K, 4000K, 6000K
MATERIAL TYPE ALUMINIUM POWDER COATED
DIMENSION
MRP



PRODUCT CODE 1912-REFLEXO SQUIRE
POWER 36W, 50W
CCT 3000K, 4000K, 6000K
MATERIAL TYPE ALUMINIUM POWDER COATED
DIMENSION
MRP



PRODUCT CODE 1919-ZAYKA
POWER 24W, 36W
CCT 3000K, 4000K, 6000K
MATERIAL TYPE ALUMINIUM POWDER COATED
DIMENSION
MRP



PRODUCT CODE 1920-GLASIA
POWER 24W, 36W
CCT 3000K, 4000K, 6000K
MATERIAL TYPE ALUMINIUM POWDER COATED
DIMENSION
MRP



PRODUCT CODE 1921-PELICAN
POWER 36W, 50W
CCT 3000K, 4000K, 6000K
MATERIAL TYPE ALUMINIUM POWDER COATED
DIMENSION
MRP



PRODUCT CODE 1913-NEBULA
POWER 24W, 36W
CCT 3000K, 4000K, 6000K
MATERIAL TYPE ALUMINIUM POWDER COATED
DIMENSION
MRP



PRODUCT CODE 1914-SIGNA
POWER 24W, 36W
CCT 3000K, 4000K, 6000K
MATERIAL TYPE ALUMINIUM POWDER COATED
DIMENSION
MRP



PRODUCT CODE 1915-PRIMA
POWER 24W, 36W
CCT 3000K, 4000K, 6000K
MATERIAL TYPE ALUMINIUM POWDER COATED
DIMENSION
MRP



PRODUCT CODE 1922-ASPEN
POWER 36W, 50W
CCT 3000K, 4000K, 6000K
MATERIAL TYPE ALUMINIUM POWDER COATED
DIMENSION
MRP



PRODUCT CODE 1923-INDIANA
POWER 36W, 50W
CCT 3000K, 4000K, 6000K
MATERIAL TYPE MS POWDER COATED
DIMENSION
MRP



PRODUCT CODE 1924-ODIN
POWER 24W, 36W
CCT 3000K, 4000K, 6000K
MATERIAL TYPE ALUMINIUM POWDER COATED
DIMENSION
MRP



PRODUCT CODE 1916-ALTRA
POWER 24W, 36W
CCT 3000K, 4000K, 6000K
MATERIAL TYPE ALUMINIUM POWDER COATED
DIMENSION
MRP



PRODUCT CODE 1917-BREZZA
POWER 24W, 36W
CCT 3000K, 4000K, 6000K
MATERIAL TYPE ALUMINIUM POWDER COATED
DIMENSION
MRP



PRODUCT CODE 1918-GLENZA
POWER 24W, 36W
CCT 3000K, 4000K, 6000K
MATERIAL TYPE ALUMINIUM POWDER COATED
DIMENSION
MRP



PRODUCT CODE 1925-AROX
POWER 24W, 50W, 100W
CCT 3000K, 4000K, 6000K
MATERIAL TYPE MS POWDER COATED
DIMENSION
MRP



PRODUCT CODE 1926-CATTAIL
POWER 24W, 50W, 100W
CCT 3000K, 4000K, 6000K
MATERIAL TYPE MS POWDER COATED
DIMENSION
MRP



PRODUCT CODE 1927-TREETOP
POWER 100W, 150W
CCT 3000K, 4000K, 6000K
MATERIAL TYPE MS POWDER COATED
DIMENSION
MRP



PRODUCT CODE 1928-ZION
POWER 36W, 50W
CCT 3000K, 4000K, 6000K
MATERIAL TYPE ALUMINIUM POWDER COATED
DIMENSION
MRP



PRODUCT CODE 1929-XON
POWER 24W, 36W
CCT 3000K, 4000K, 6000K
MATERIAL TYPE ALUMINIUM POWDER COATED
DIMENSION
MRP



PRODUCT CODE 1930-NEXON
POWER 24W, 36W
CCT 3000K, 4000K, 6000K
MATERIAL TYPE ALUMINIUM POWDER COATED
DIMENSION
MRP



PRODUCT CODE 1937-NURA
POWER 24W, 36W
CCT 3000K, 4000K, 6000K
MATERIAL TYPE MS POWDER COATED
DIMENSION
MRP



PRODUCT CODE 1938-AURA
POWER 24W, 36W
CCT 3000K, 4000K, 6000K
MATERIAL TYPE MS POWDER COATED
DIMENSION
MRP



PRODUCT CODE 1939-VONDA
POWER 24W, 36W
CCT 3000K, 4000K, 6000K
MATERIAL TYPE MS POWDER COATED
DIMENSION
MRP



PRODUCT CODE 1931-BECON
POWER 36W, 50W
CCT 3000K, 4000K, 6000K
MATERIAL TYPE MS POWDER COATED
DIMENSION
MRP



PRODUCT CODE 1932-SAFFRON
POWER 36W, 50W
CCT 3000K, 4000K, 6000K
MATERIAL TYPE MS POWDER COATED
DIMENSION
MRP



PRODUCT CODE 1933-ARON
POWER 24W, 36W
CCT 3000K, 4000K, 6000K
MATERIAL TYPE ALUMINIUM POWDER COATED
DIMENSION
MRP



PRODUCT CODE 1940-UJALA
POWER 24W, 36W
CCT 3000K, 4000K, 6000K
MATERIAL TYPE MS POWDER COATED
DIMENSION
MRP



PRODUCT CODE 1941-KORRIA
POWER 24W, 36W
CCT 3000K, 4000K, 6000K
MATERIAL TYPE MS POWDER COATED
DIMENSION
MRP



PRODUCT CODE 1924-AABHA
POWER 24W, 36W
CCT 3000K, 4000K, 6000K
MATERIAL TYPE MS POWDER COATED
DIMENSION
MRP



PRODUCT CODE 1934-EYON
POWER 24W, 36W
CCT 3000K, 4000K, 6000K
MATERIAL TYPE MS POWDER COATED
DIMENSION
MRP



PRODUCT CODE 1935-LIVON
POWER 24W, 36W
CCT 3000K, 4000K, 6000K
MATERIAL TYPE MS POWDER COATED
DIMENSION
MRP



PRODUCT CODE 1936-NION
POWER 24W, 36W
CCT 3000K, 4000K, 6000K
MATERIAL TYPE MS POWDER COATED
DIMENSION
MRP



PRODUCT CODE 1943-ZILLIKA
POWER 24W, 36W
CCT 3000K, 4000K, 6000K
MATERIAL TYPE MS POWDER COATED
DIMENSION
MRP



PRODUCT CODE 1944-ELECTRA
POWER 24W, 36W
CCT 3000K, 4000K, 6000K
MATERIAL TYPE MS POWDER COATED
DIMENSION
MRP



PRODUCT CODE 1945-VITARA
POWER 24W, 36W
CCT 3000K, 4000K, 6000K
MATERIAL TYPE MS POWDER COATED
DIMENSION
MRP



LED GATE LIGHTS



PRODUCT CODE GL-01
WATT 5W, 10W
COLOUR 3000K, 4000K, 6000K
MATERIAL TYPE ALUMINIUM CASTING / M.S. POWDER COTED / S.S / PC



PRODUCT CODE GL-02
WATT 5W, 10W
COLOUR 3000K, 4000K, 6000K
MATERIAL TYPE ALUMINIUM CASTING / M.S. POWDER COTED / S.S / PC



PRODUCT CODE GL-03
WATT 5W, 10W
COLOUR 3000K, 4000K, 6000K
MATERIAL TYPE ALUMINIUM CASTING / M.S. POWDER COTED / S.S / PC



PRODUCT CODE GL-04
WATT 5W, 10W
COLOUR 3000K, 4000K, 6000K
MATERIAL TYPE ALUMINIUM CASTING / M.S. POWDER COTED / S.S / PC



PRODUCT CODE GL-05
WATT 5W, 10W
COLOUR 3000K, 4000K, 6000K
MATERIAL TYPE ALUMINIUM CASTING / M.S. POWDER COTED / S.S / PC



PRODUCT CODE GL-06
WATT 5W, 10W
COLOUR 3000K, 4000K, 6000K
MATERIAL TYPE ALUMINIUM CASTING / M.S. POWDER COTED / S.S / PC



PRODUCT CODE GL-07
WATT 5W, 10W
COLOUR 3000K, 4000K, 6000K
MATERIAL TYPE ALUMINIUM CASTING / M.S. POWDER COTED / S.S / PC



PRODUCT CODE GL-08
WATT 5W, 10W
COLOUR 3000K, 4000K, 6000K
MATERIAL TYPE ALUMINIUM CASTING / M.S. POWDER COTED / S.S / PC



PRODUCT CODE GL-09
WATT 5W, 10W
COLOUR 3000K, 4000K, 6000K
MATERIAL TYPE ALUMINIUM CASTING / M.S. POWDER COTED / S.S / PC



PRODUCT CODE GL-10
WATT 5W, 10W
COLOUR 3000K, 4000K, 6000K
MATERIAL TYPE ALUMINIUM CASTING /
M.S. POWDER COTED /
S.S / PC



PRODUCT CODE GL-11
WATT 5W, 10W
COLOUR 3000K, 4000K, 6000K
MATERIAL TYPE ALUMINIUM CASTING /
M.S. POWDER COTED /
S.S / PC



PRODUCT CODE GL-12
WATT 5W, 10W
COLOUR 3000K, 4000K, 6000K
MATERIAL TYPE ALUMINIUM CASTING /
M.S. POWDER COTED /
S.S / PC



PRODUCT CODE GL-19
WATT 5W, 10W
COLOUR 3000K, 4000K, 6000K
MATERIAL TYPE ALUMINIUM CASTING /
M.S. POWDER COTED /
S.S / PC



PRODUCT CODE GL-20
WATT 5W, 10W
COLOUR 3000K, 4000K, 6000K
MATERIAL TYPE ALUMINIUM CASTING /
M.S. POWDER COTED /
S.S / PC



PRODUCT CODE GL-21
WATT 5W, 10W
COLOUR 3000K, 4000K, 6000K
MATERIAL TYPE ALUMINIUM CASTING /
M.S. POWDER COTED /
S.S / PC



PRODUCT CODE GL-13
WATT 5W, 10W
COLOUR 3000K, 4000K, 6000K
MATERIAL TYPE ALUMINIUM CASTING /
M.S. POWDER COTED /
S.S / PC



PRODUCT CODE GL-14
WATT 5W, 10W
COLOUR 3000K, 4000K, 6000K
MATERIAL TYPE ALUMINIUM CASTING /
M.S. POWDER COTED /
S.S / PC



PRODUCT CODE GL-15
WATT 5W, 10W
COLOUR 3000K, 4000K, 6000K
MATERIAL TYPE ALUMINIUM CASTING /
M.S. POWDER COTED /
S.S / PC



PRODUCT CODE GL-22
WATT 5W, 10W
COLOUR 3000K, 4000K, 6000K
MATERIAL TYPE ALUMINIUM CASTING /
M.S. POWDER COTED /
S.S / PC



PRODUCT CODE GL-23
WATT 5W, 10W
COLOUR 3000K, 4000K, 6000K
MATERIAL TYPE ALUMINIUM CASTING /
M.S. POWDER COTED /
S.S / PC



PRODUCT CODE GL-24
WATT 5W, 10W
COLOUR 3000K, 4000K, 6000K
MATERIAL TYPE ALUMINIUM CASTING /
M.S. POWDER COTED /
S.S / PC



PRODUCT CODE GL-16
WATT 5W, 10W
COLOUR 3000K, 4000K, 6000K
MATERIAL TYPE ALUMINIUM CASTING /
M.S. POWDER COTED /
S.S / PC



PRODUCT CODE GL-17
WATT 5W, 10W
COLOUR 3000K, 4000K, 6000K
MATERIAL TYPE ALUMINIUM CASTING /
M.S. POWDER COTED /
S.S / PC



PRODUCT CODE GL-18
WATT 5W, 10W
COLOUR 3000K, 4000K, 6000K
MATERIAL TYPE ALUMINIUM CASTING /
M.S. POWDER COTED /
S.S / PC



PRODUCT CODE GL-25
WATT 5W, 10W
COLOUR 3000K, 4000K, 6000K
MATERIAL TYPE ALUMINIUM CASTING /
M.S. POWDER COTED /
S.S / PC



PRODUCT CODE GL-26
WATT 5W, 10W
COLOUR 3000K, 4000K, 6000K
MATERIAL TYPE ALUMINIUM CASTING /
M.S. POWDER COTED /
S.S / PC



PRODUCT CODE GL-27
WATT 5W, 10W
COLOUR 3000K, 4000K, 6000K
MATERIAL TYPE ALUMINIUM CASTING /
M.S. POWDER COTED /
S.S / PC



PRODUCT CODE GL-28
WATT 5W, 10W
COLOUR 3000K, 4000K, 6000K
MATERIAL TYPE ALUMINIUM CASTING /
M.S. POWDER COTED /
S.S / PC

PRODUCT CODE GL-29
WATT 5W, 10W
COLOUR 3000K, 4000K, 6000K
MATERIAL TYPE ALUMINIUM CASTING /
M.S. POWDER COTED /
S.S / PC

PRODUCT CODE GL-30
WATT 5W, 10W
COLOUR 3000K, 4000K, 6000K
MATERIAL TYPE ALUMINIUM CASTING /
M.S. POWDER COTED /
S.S / PC

PRODUCT CODE GL-37
WATT 5W, 10W
COLOUR 3000K, 4000K, 6000K
MATERIAL TYPE ALUMINIUM CASTING /
M.S. POWDER COTED /
S.S / PC

PRODUCT CODE GL-38
WATT 5W, 10W
COLOUR 3000K, 4000K, 6000K
MATERIAL TYPE ALUMINIUM CASTING /
M.S. POWDER COTED /
S.S / PC

PRODUCT CODE GL-39
WATT 5W, 10W
COLOUR 3000K, 4000K, 6000K
MATERIAL TYPE ALUMINIUM CASTING /
M.S. POWDER COTED /
S.S / PC



PRODUCT CODE GL-31
WATT 5W, 10W
COLOUR 3000K, 4000K, 6000K
MATERIAL TYPE ALUMINIUM CASTING /
M.S. POWDER COTED /
S.S / PC

PRODUCT CODE GL-32
WATT 5W, 10W
COLOUR 3000K, 4000K, 6000K
MATERIAL TYPE ALUMINIUM CASTING /
M.S. POWDER COTED /
S.S / PC

PRODUCT CODE GL-33
WATT 5W, 10W
COLOUR 3000K, 4000K, 6000K
MATERIAL TYPE ALUMINIUM CASTING /
M.S. POWDER COTED /
S.S / PC

PRODUCT CODE GL-40
WATT 5W, 10W
COLOUR 3000K, 4000K, 6000K
MATERIAL TYPE ALUMINIUM CASTING /
M.S. POWDER COTED /
S.S / PC

PRODUCT CODE GL-41
WATT 5W, 10W
COLOUR 3000K, 4000K, 6000K
MATERIAL TYPE ALUMINIUM CASTING /
M.S. POWDER COTED /
S.S / PC

PRODUCT CODE GL-42
WATT 5W, 10W
COLOUR 3000K, 4000K, 6000K
MATERIAL TYPE ALUMINIUM CASTING /
M.S. POWDER COTED /
S.S / PC



PRODUCT CODE GL-34
WATT 5W, 10W
COLOUR 3000K, 4000K, 6000K
MATERIAL TYPE ALUMINIUM CASTING /
M.S. POWDER COTED /
S.S / PC

PRODUCT CODE GL-35
WATT 5W, 10W
COLOUR 3000K, 4000K, 6000K
MATERIAL TYPE ALUMINIUM CASTING /
M.S. POWDER COTED /
S.S / PC

PRODUCT CODE GL-36
WATT 5W, 10W
COLOUR 3000K, 4000K, 6000K
MATERIAL TYPE ALUMINIUM CASTING /
M.S. POWDER COTED /
S.S / PC

PRODUCT CODE GL-43
WATT 5W, 10W
COLOUR 3000K, 4000K, 6000K
MATERIAL TYPE ALUMINIUM CASTING /
M.S. POWDER COTED /
S.S / PC

PRODUCT CODE GL-44
WATT 5W, 10W
COLOUR 3000K, 4000K, 6000K
MATERIAL TYPE ALUMINIUM CASTING /
M.S. POWDER COTED /
S.S / PC

PRODUCT CODE GL-45
WATT 5W, 10W
COLOUR 3000K, 4000K, 6000K
MATERIAL TYPE ALUMINIUM CASTING /
M.S. POWDER COTED /
S.S / PC



PRODUCT CODE GL-46
WATT 5W, 10W
COLOUR 3000K, 6000K
MATERIAL TYPE ALUMINIUM CASTING /
M.S. POWDER COTED /
S.S / PC



PRODUCT CODE GL-47
WATT 5W, 10W
COLOUR 3000K, 4000K, 6000K
MATERIAL TYPE ALUMINIUM CASTING /
M.S. POWDER COTED /
S.S / PC



PRODUCT CODE GL-48
WATT 5W, 7W, 10W
COLOUR 3000K, 4000K, 6000K
MATERIAL TYPE ALUMINIUM CASTING /
M.S. POWDER COTED /
S.S / PC



PRODUCT CODE GL-49
WATT 5W, 10W
COLOUR 3000K, 4000K, 6000K
MATERIAL TYPE ALUMINIUM CASTING /
M.S. POWDER COTED /
S.S / PC



PRODUCT CODE GL-50
WATT 5W, 10W
COLOUR 3000K, 4000K, 6000K
MATERIAL TYPE ALUMINIUM CASTING /
M.S. POWDER COTED /
S.S / PC



PRODUCT CODE GL-51
WATT 5W, 10W
COLOUR 3000K, 4000K, 6000K
MATERIAL TYPE ALUMINIUM CASTING /
M.S. POWDER COTED /
S.S / PC



PRODUCT CODE GL-52
WATT 5W, 10W
COLOUR 3000K, 4000K, 6000K
MATERIAL TYPE ALUMINIUM CASTING /
M.S. POWDER COTED /
S.S / PC



PRODUCT CODE GL-53
WATT 5W, 10W
COLOUR 3000K, 4000K, 6000K
MATERIAL TYPE ALUMINIUM CASTING /
M.S. POWDER COTED /
S.S / PC



PRODUCT CODE GL-54
WATT 5W, 10W
COLOUR 3000K, 4000K, 6000K
MATERIAL TYPE ALUMINIUM CASTING /
M.S. POWDER COTED /
S.S / PC

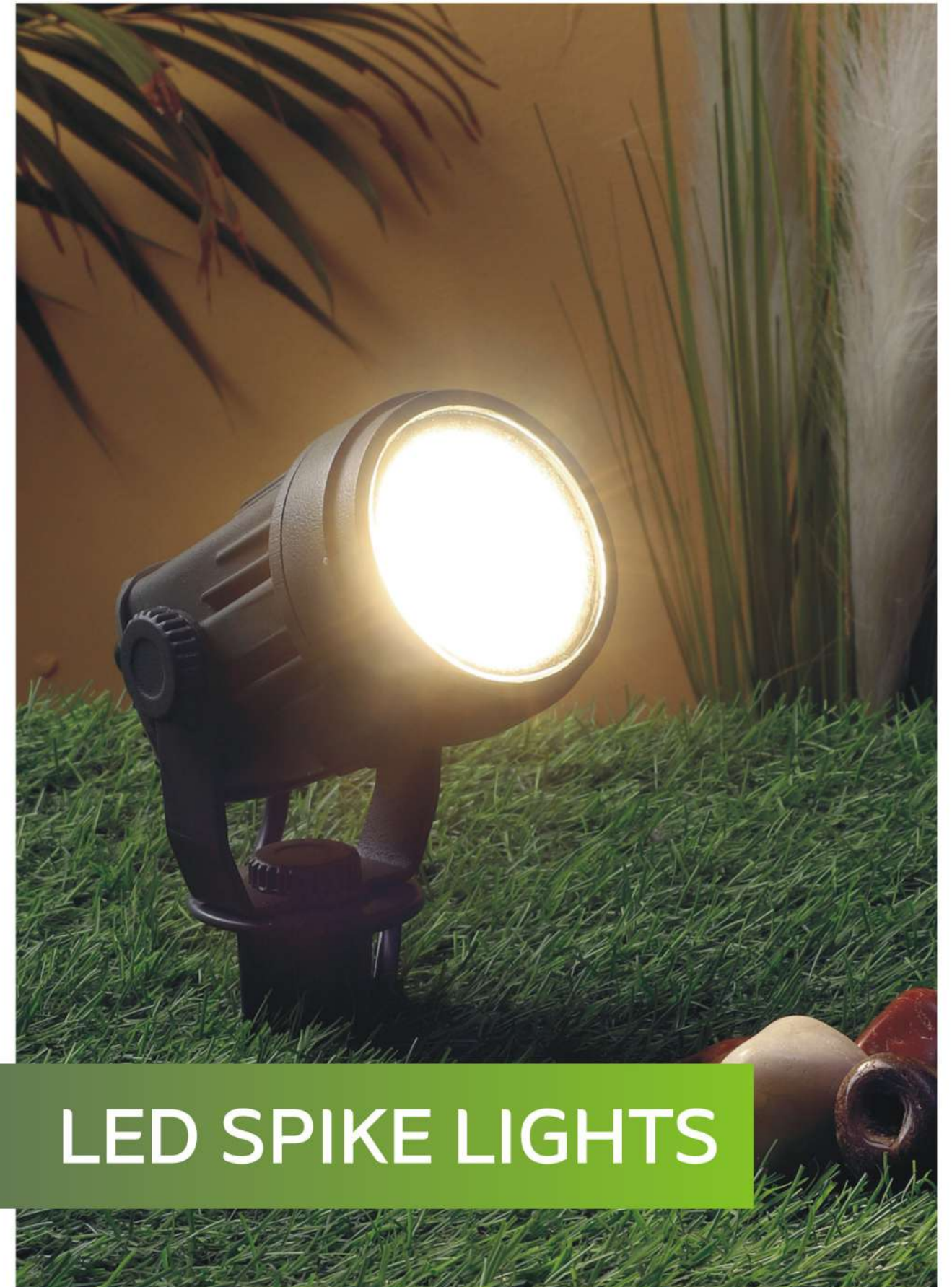

LED SPIKE LIGHTS



PRODUCT CODE SPL-01
WATT 5W, 7W, 9W
COLOUR 3000K, RGB,
MATERIAL TYPE ALUMINIUM SS
IP IP65



PRODUCT CODE SPL-02
WATT 5W, 7W, 9W
COLOUR 3000K, RGB,
MATERIAL TYPE ALUMINIUM SS
IP IP65



PRODUCT CODE SPL-03
WATT 5W, 7W, 9W
COLOUR 3000K, RGB,
MATERIAL TYPE ALUMINIUM SS
IP IP65



PRODUCT CODE SPL-04
WATT 5W, 7W, 9W
COLOUR 3000K, RGB,
MATERIAL TYPE ALUMINIUM SS
IP IP65



PRODUCT CODE SPL-05
WATT 5W, 7W, 9W
COLOUR 3000K, RGB,
MATERIAL TYPE ALUMINIUM SS
IP IP65



PRODUCT CODE SPL-06
WATT 5W, 7W, 9W
COLOUR 3000K, RGB,
MATERIAL TYPE ALUMINIUM SS
IP IP65



PRODUCT CODE SPL-07
WATT 5W, 7W, 9W
COLOUR 3000K, RGB,
MATERIAL TYPE ALUMINIUM SS
IP IP65



PRODUCT CODE SPL-08
WATT 5W, 7W, 9W
COLOUR 3000K, RGB,
MATERIAL TYPE ALUMINIUM SS
IP IP65



PRODUCT CODE SPL-09
WATT 5W, 7W, 9W
COLOUR 3000K, RGB,
MATERIAL TYPE ALUMINIUM SS
IP IP65



LED WALL LIGHTS



PRODUCT CODE WL-01
WATT 5W
COLOUR 3000K
MATERIAL TYPE ALUMINIUM CASTING
IP IP65



PRODUCT CODE WL-02
WATT 5W X 2
COLOUR 3000K
MATERIAL TYPE ALUMINIUM CASTING
IP IP65



PRODUCT CODE WL-03
WATT 5W X 2
COLOUR 3000K
MATERIAL TYPE ALUMINIUM CASTING
IP IP65



PRODUCT CODE WL-10
WATT 5W X 4
COLOUR 3000K
MATERIAL TYPE ALUMINIUM CASTING
IP IP65



PRODUCT CODE WL-11
WATT 5W X 5
COLOUR 3000K
MATERIAL TYPE ALUMINIUM CASTING
IP IP65



PRODUCT CODE WL-12
WATT 5W X 3
COLOUR 3000K
MATERIAL TYPE ALUMINIUM CASTING
IP IP65



PRODUCT CODE WL-04
WATT 5W X 2
COLOUR 3000K
MATERIAL TYPE ALUMINIUM CASTING
IP IP65



PRODUCT CODE WL-05
WATT 5W X 4
COLOUR 3000K
MATERIAL TYPE ALUMINIUM CASTING
IP IP65



PRODUCT CODE WL-06
WATT 5W X 4
COLOUR 3000K
MATERIAL TYPE ALUMINIUM CASTING
IP IP65



PRODUCT CODE WL-13
WATT 5W X 1, 5W X 2
COLOUR 3000K
MATERIAL TYPE ALUMINIUM CASTING
IP IP65



PRODUCT CODE WL-14
WATT 5W X 4, 5W X 2
COLOUR 3000K
MATERIAL TYPE ALUMINIUM CASTING
IP IP65



PRODUCT CODE WL-15
WATT 5W X 2
COLOUR 3000K
MATERIAL TYPE ALUMINIUM CASTING
IP IP65



PRODUCT CODE WL-07
WATT 5W X 2, 5W X 4, 5W X 6,
COLOUR 3000K
MATERIAL TYPE ALUMINIUM CASTING
IP IP65



PRODUCT CODE WL-08
WATT 5W X 2, 5W X 4, 5W X 6,
COLOUR 3000K
MATERIAL TYPE ALUMINIUM CASTING
IP IP65



PRODUCT CODE WL-09
WATT 3W X 2, 5W X 2
COLOUR 3000K
MATERIAL TYPE ALUMINIUM CASTING
IP IP65



PRODUCT CODE WL-16
WATT 10W
COLOUR 3000K
MATERIAL TYPE ALUMINIUM CASTING
IP IP65



PRODUCT CODE WL-17
WATT 10W
COLOUR 3000K
MATERIAL TYPE ALUMINIUM CASTING
IP IP65



PRODUCT CODE WL-18
WATT 10W
COLOUR 3000K
MATERIAL TYPE ALUMINIUM CASTING
IP IP65



PRODUCT CODE WL-19
WATT 5W X 2
COLOUR 3000K
MATERIAL TYPE ALUMINIUM CASTING
IP IP65



PRODUCT CODE WL-20
WATT 5W X 2
COLOUR 3000K
MATERIAL TYPE ALUMINIUM CASTING
IP IP65



PRODUCT CODE WL-21
WATT 10W
COLOUR 3000K
MATERIAL TYPE ALUMINIUM CASTING
IP IP65



PRODUCT CODE WL-28
WATT 5W
COLOUR 3000K
MATERIAL TYPE ALUMINIUM CASTING
IP IP65



PRODUCT CODE WL-29
WATT 5W
COLOUR 3000K
MATERIAL TYPE ALUMINIUM CASTING
IP IP65



PRODUCT CODE WL-30
WATT 5W
COLOUR 3000K
MATERIAL TYPE ALUMINIUM CASTING
IP IP65



PRODUCT CODE WL-22
WATT 10W
COLOUR 3000K
MATERIAL TYPE ALUMINIUM CASTING
IP IP65

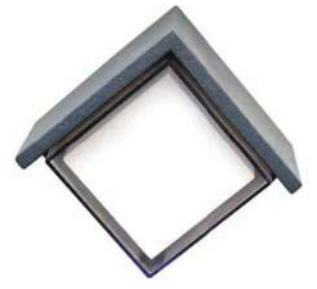

PRODUCT CODE WL-23
WATT 10W
COLOUR 3000K
MATERIAL TYPE ALUMINIUM CASTING
IP IP65



PRODUCT CODE WL-24
WATT 10W
COLOUR 3000K
MATERIAL TYPE ALUMINIUM CASTING
IP IP65



PRODUCT CODE WL-31
WATT 5W
COLOUR 3000K
MATERIAL TYPE ALUMINIUM CASTING
IP IP65



PRODUCT CODE WL-32
WATT 5W
COLOUR 3000K
MATERIAL TYPE ALUMINIUM CASTING
IP IP65



PRODUCT CODE WL-33
WATT 5W
COLOUR 3000K
MATERIAL TYPE ALUMINIUM CASTING
IP IP65



PRODUCT CODE WL-25
WATT 5W
COLOUR 3000K
MATERIAL TYPE ALUMINIUM CASTING
IP IP65



PRODUCT CODE WL-26
WATT 5W X 2
COLOUR 3000K
MATERIAL TYPE ALUMINIUM CASTING
IP IP65



PRODUCT CODE WL-27
WATT 5W X 2
COLOUR 3000K
MATERIAL TYPE ALUMINIUM CASTING
IP IP65



PRODUCT CODE WL-34
WATT 5W, 7W
COLOUR 3000K
MATERIAL TYPE ALUMINIUM CASTING
IP IP65



PRODUCT CODE WL-35
WATT 5W, 7W
COLOUR 3000K
MATERIAL TYPE ALUMINIUM CASTING
IP IP65



PRODUCT CODE WL-36
WATT 5W, 7W
COLOUR 3000K
MATERIAL TYPE ALUMINIUM CASTING
IP IP65

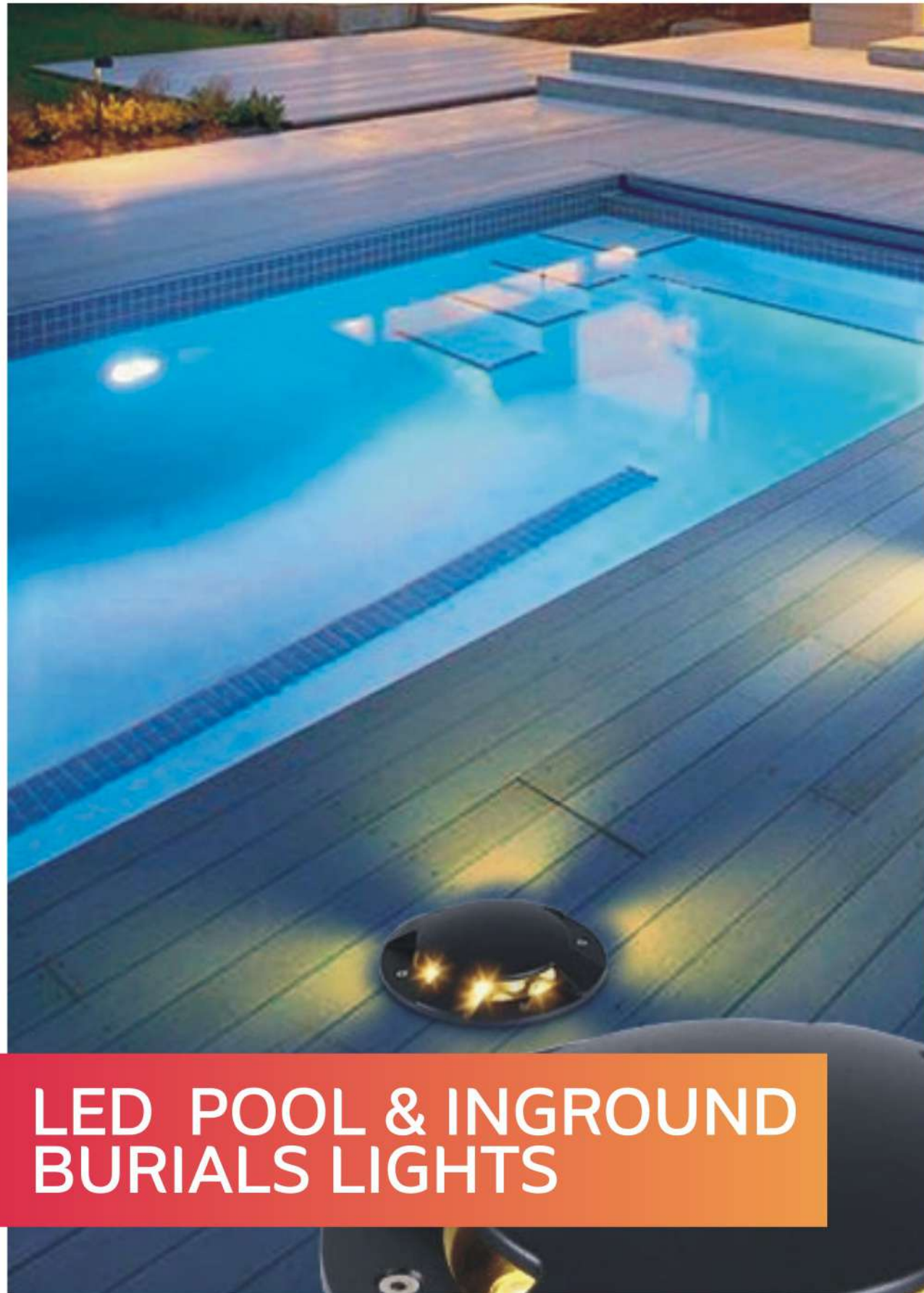

LED POOL & INGROUND BURIALS LIGHTS



PRODUCT CODE PLAL-01
PRODUCT TYPE SURFACE MULTI LED POOL LIGHTS
WATT 3W, 6W, 9W, 12W, 18W, 27W, 36W
COLOUR SINGLE COLOUR & RGB
MATERIAL TYPE SS
DIAMETER 50 MM, 100 MM, 125 MM, 150 MM
THICKNESS 22 MM, 25 MM
IP IP 67



PRODUCT CODE PLABS-02
PRODUCT TYPE SURFACE MULTI LED POOL LIGHTS
WATT 6W, 9W, 12W, 18W, 27W, 36W
COLOUR SINGLE COLOUR & RGB
MATERIAL TYPE ABS
DIAMETER 165 MM, 225 MM 280 MM
THICKNESS 40 MM,
IP IP 67



PRODUCT CODE PLSS-03
PRODUCT TYPE SURFACE MULTI LED POOL LIGHTS
WATT 6W, 9W, 12W, 18W, 27W, 36W
COLOUR SINGLE COLOUR & RGB
MATERIAL TYPE SS
DIAMETER 200 MM
THICKNESS 35 MM,
IP IP 67



PRODUCT CODE PLSPT-04
PRODUCT TYPE SPOT LED FOUNTAIN LIGHTS
WATT 3W, 6W, 9W, 12W, 18W, 27W, 36W
COLOUR SINGLE COLOUR & RGB
MATERIAL TYPE SS
DIAMETER 76MM 100MM 125MM 150MM
THICKNESS 25 MM
IP IP 67



PRODUCT CODE PLNOZ-05
PRODUCT TYPE NOZEL LED FOUNTAIN LIGHTS
WATT 9W, 12W, 18W, 27W, 36W
COLOUR SINGLE COLOUR & RGB
MATERIAL TYPE SS
DIAMETER 100MM 125MM 150MM
THICKNESS 32 MM
IP IP 67



PRODUCT CODE IGBL-01
PRODUCT TYPE INGROUND BURIAL LIGHTS (COB)
WATT 3W, 6W,
COLOUR SINGLE COLOUR & RGB
MATERIAL TYPE SS
DIAMETER 25 MM, 35 MM,
THICKNESS IP 67
IP



PRODUCT CODE IGBL-02
PRODUCT TYPE INGROUND BURIAL LIGHTS (MULTI LED)
WATT 6W, 9W, 12W, 18W, 27W, 36W
COLOUR SINGLE COLOUR & RGB
MATERIAL TYPE SS
DIAMETER 50 MM, 90 MM, 155 MM
THICKNESS IP 67
IP



PRODUCT CODE IGBL-03
PRODUCT TYPE INGROUND BURIAL LIGHTS (SIDE WAY)
WATT 3W, 7W
COLOUR SINGLE COLOUR & RGB
MATERIAL TYPE SS
DIAMETER 60 MM
THICKNESS IP 67
IP



PRODUCT CODE IGBL-04
PRODUCT TYPE INGROUND BURIAL LIGHTS (LINEAR)
WATT 6W, 12W, 24W
COLOUR SINGLE COLOUR & RGB
MATERIAL TYPE SS
DIAMETER 300 MM, 600 MM
THICKNESS IP 67
IP

LED FACADE LIGHTS



PRODUCT CODE 1702
WATT 10W, 20W, 30W, 50W, 100W, 200W
COLOUR SINGLE COLOUR & RGB
MATERIAL TYPE ALUMINIUM CASTING
IP IP 65



PRODUCT CODE 1703
WATT 10W, 20W, 30W, 50W
COLOUR SINGLE COLOUR & RGB
MATERIAL TYPE ALUMINIUM CASTING
IP IP 65



PRODUCT CODE 1505-01
WATT 24 TO 240 WATT
(AS PER CUSTOMIZED)
COLOUR 3000K, 4000K, 6500K
MATERIAL TYPE ALUMINIUM OR MS BODY
DIMENSION 50 MM X 70 MM
LENGTH 600 MM, 1200 MM, 1800 MM, 2400 MM
3000 MM, 3600 MM

PRODUCT CODE 1505-02
WATT 30 TO 120 WATT
(AS PER CUSTOMIZED)
COLOUR 3000K, 4000K, 6500K
MATERIAL TYPE ALUMINIUM OR MS BODY
DIMENSION 400 MM, 600 MM, 800 MM, 1200 MM

PRODUCT CODE 1505-03
WATT 30 TO 120 WATT
(AS PER CUSTOMIZED)
COLOUR 3000K, 4000K, 6500K
MATERIAL TYPE ALUMINIUM OR MS BODY
DIMENSION 400 MM, 600 MM, 800 MM, 1200 MM

LED HANGING LIGHTS



LED LINEAR & MAGNETIC LIGHTS



PRODUCT CODE NE1506-01
WATT 03W, 06W, 12W, 18W, 24W
COLOUR 3000K, 4000K, 6500K
MATERIAL TYPE ALUMINIUM BODY



PRODUCT CODE NE1506-02
WATT 06W, 12W, 18W, 24W
COLOUR 3000K, 4000K, 6500K
MATERIAL TYPE ALUMINIUM BODY



PRODUCT CODE NE1507
WATT 06W, 10W, 20W, 30W
COLOUR 3000K, 4000K, 6500K
MATERIAL TYPE ALUMINIUM BODY

LED PANEL LIGHTS



PRODUCT CODE NE101
WATT 09W, 15W, 22W,
COLOUR 3000K, 4000K, 6500K
MATERIAL TYPE ALUMINIUM BODY



PRODUCT CODE NE103
WATT 09W, 15W, 22W,
COLOUR 3000K, 4000K, 6500K
MATERIAL TYPE ALUMINIUM BODY



PRODUCT CODE NE109
WATT 09W, 15W, 22W,
COLOUR 3000K, 4000K, 6500K
MATERIAL TYPE PC BODY



PRODUCT CODE NE401
WATT 05W, 7W, 9W, 12W, 15W, 24W
COLOUR 3000K, 4000K, 6500K
MATERIAL TYPE ALUMINIUM BODY



PRODUCT CODE Ne402
WATT 05W, 7W, 12W
COLOUR 3000K, 4000K, 6500K
MATERIAL TYPE ALUMINIUM BODY



PRODUCT CODE NE403
WATT 07W, 12W, 18W
COLOUR 3000K, 4000K, 6500K
MATERIAL TYPE ALUMINIUM BODY

LED SPOT LIGHTS



LED COMMERCIAL LIGHTS



PRODUCT CODE NE501
WATT 10W, 20W, 30W
COLOUR 3000K, 4000K, 6500K
MATERIAL TYPE ALUMINIUM BODY



PRODUCT CODE NE601
WATT 06W, 12W, 18W
COLOUR 3000K, 4000K, 6500K
MATERIAL TYPE ALUMINIUM BODY



PRODUCT CODE NE1501
SIZE 17 MM, 25 MM, 35 MM, 50 MM, 75 MM
MATERIAL TYPE ALUMINIUM BODY

LED STREET LIGHT



PRODUCT CODE NE702
WATT 24W, 36W, 50W, 100W, 120W
COLOUR 3000K, 4000K, 6500K
MATERIAL TYPE ALUMINIUM BODY
IP IP65



PRODUCT CODE NE705
WATT 24W, 36W, 50W, 100W
COLOUR 3000K, 4000K, 6500K
MATERIAL TYPE ALUMINIUM BODY
IP IP65



PRODUCT CODE NE706
WATT 24W, 36W, 50W, 100W, 120W
COLOUR 3000K, 4000K, 6500K
MATERIAL TYPE ALUMINIUM BODY
IP IP65

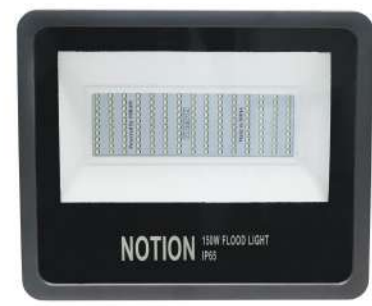

PRODUCT CODE NE802
WATT 20W, 30W, 50W, 100W, 150W, 200W
COLOUR 3000K, 4000K, 6500K
MATERIAL TYPE ALUMINIUM BODY
IP IP65



PRODUCT CODE NE805
WATT 20W, 30W, 50W, 100W, 150W, 200W
COLOUR 3000K, 4000K, 6500K
MATERIAL TYPE ALUMINIUM BODY
IP IP65



PRODUCT CODE NE806
WATT 30W, 50W, 100W
COLOUR 3000K, 4000K, 6500K
MATERIAL TYPE ALUMINIUM BODY
IP IP65

LED FLOOD LIGHTS



PRODUCT CODE NE1002
WATT 150W, 200W, 250W
COLOUR 3000K, 4000K, 6500K
MATERIAL TYPE ALUMINIUM BODY
IP IP65



PRODUCT CODE NE1003
WATT 50W, 100W, 150W
COLOUR 3000K, 4000K, 6500K
MATERIAL TYPE ALUMINIUM BODY
IP IP65



PRODUCT CODE NE1004
WATT 50W, 100W, 150W, 200W
COLOUR 3000K, 4000K, 6500K
MATERIAL TYPE ALUMINIUM BODY
IP IP65

LED HIGHBAY LIGHTS

